

USER MANUAL

ELECTRICAL APPLIANCE SAFETY TESTERS

PAT-810 • PAT-815 • PAT-820

PAT-820 (810, 815)

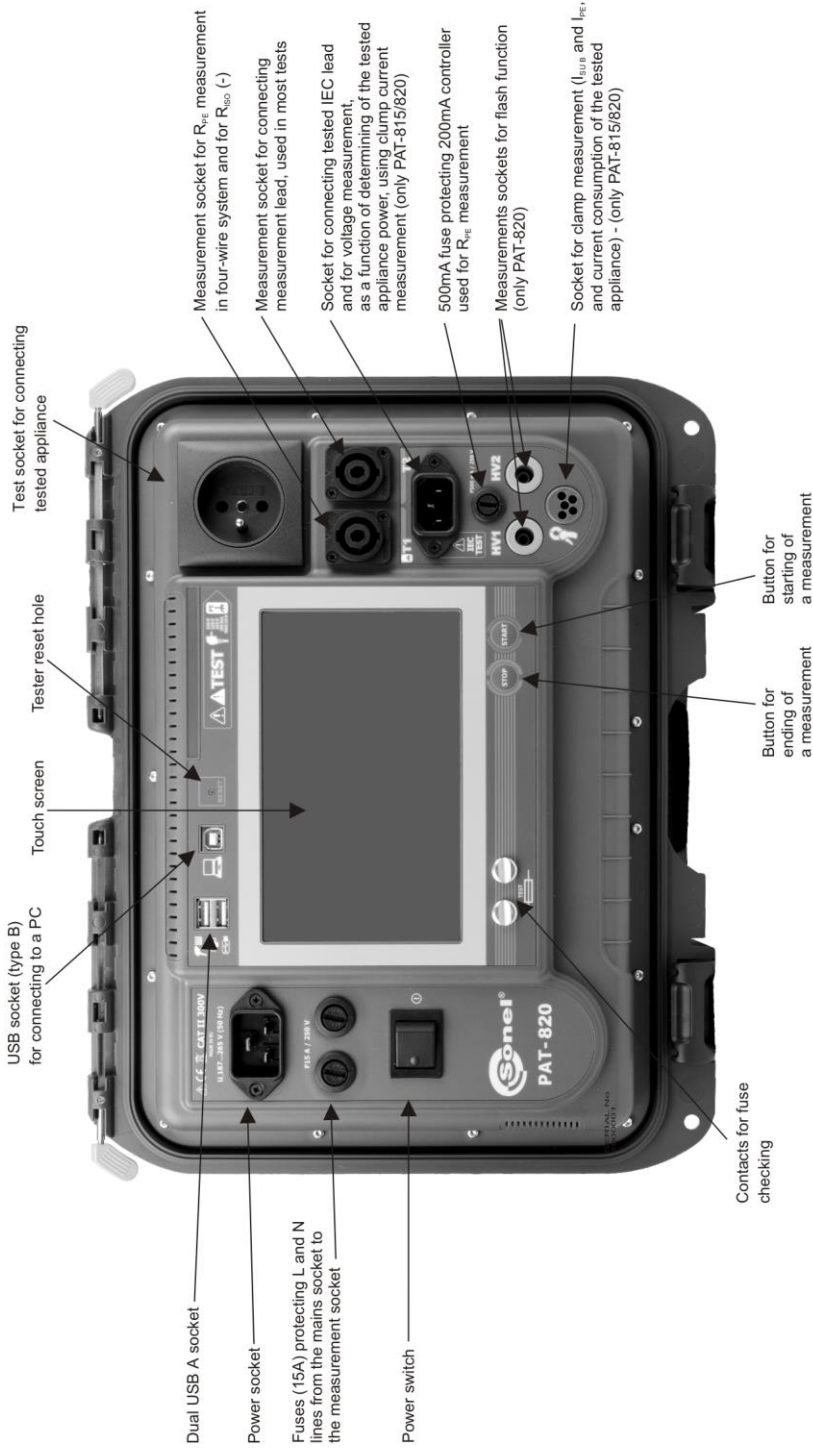



USER MANUAL

ELECTRICAL APPLIANCE SAFETY TESTERS PAT-810 • PAT-815 • PAT-820



**SONEL S.A.
Wokulskiego 11
58-100 Świdnica, Poland**

Version 1.13 08.03.2022

PAT-810/815/820 testers are modern, high-quality testers, easy and safe in operation. Please acquaint yourself with the present manual in order to avoid measuring errors and prevent possible problems related to operation of the tester.

TABLE OF CONTENTS

1 Safety	5
2 General description and features of the instrument	6
3 Switching on and Main Menu	8
3.1 Power supply	8
3.2 Start test after switching the tester on.....	8
3.3 General settings – MENU	9
3.3.1 Symbols on screen	10
3.3.2 Setting date and time	11
3.3.3 Interface settings	13
3.3.4 Measurement settings.....	14
3.3.5 Printing	15
3.3.6 PAT specifications	16
3.3.7 Firmware upgrade.....	17
3.3.8 Information about tester and producer.....	19
3.3.9 Service.....	19
3.3.10 Network setting.....	19
3.3.11 List of Users.....	22
3.3.12 Memory structure (Clients, Objects, Subobjects and Appliances)	24
3.3.12.1 Adding Clients	24
3.3.12.2 Adding Objects.....	26
3.3.12.3 Adding Appliances.....	28
3.3.12.4 Deleting clients, objects and appliances.	29
3.3.13 Communication with PC.....	30
4 Measurements	31
4.1 Preliminary test	31
4.2 Measurement of PE resistance	32
4.3 Measurement of insulation resistance.....	35
4.3.1 Measurement of R_{ISO} on Class I devices.....	36
4.3.2 Measurement without using the test socket	37
4.3.3 Measurement of R_{ISO} on Class II (III) devices	37
4.3.4 R_{ISO} measurement of IEC power cord	38
4.4 Durability of insulation (flash test) – only PAT-820	38
4.4.1 Measurement on Class I devices	39
4.4.2 Measurement on Class II devices	40
4.5 Measurement of substitute leakage current.....	41
4.6 Measurement of PE leakage current.....	43
4.7 Measurement of differential leakage current.....	45
4.8 Measurement of touch leakage current.....	48
4.9 Measurement of P and S Power, PF Power Factor, current consumption and voltage	50
4.10 Current measurement with clamp (only PAT-815 and PAT-820).....	52
4.11 IEC cable test.....	54
4.12 Measurement of fixed RCD parameters.....	56
4.13 AUTO mode tests.....	58
4.13.1 Configuring AUTO mode tests	58
4.13.2 AUTO mode tests	59
4.13.3 Measurements (of items like IEC leads, extension leads) with RCD in AUTO mode	62

5	Memory of measurement results data	67
5.1	Storing the measurement results in the memory	67
5.2	Browsing memory data	68
5.3	'Search' option in the memory	69
5.4	Moving Appliance into another Object	71
5.5	Copying Client's data from memory into USB flash drive (back and forth)	72
5.6	Deleting memory data	73
6	Label printing	73
7	Cleaning and maintenance	75
8	Storage	75
9	Dismantling and disposal	75
10	Specifications	76
11	Accessories	83
11.1	Standard accessories	83
11.2	Optional accessories	83
12	Manufacturer	85
13	Laboratory services	86

1 Safety

PAT-810/815/820 testers are designed for performing check tests on electrical equipment, providing measurement results which determine the safety status of tested devices. Therefore, in order to provide conditions for correct operation and the correctness of the obtained results, the following recommendations must be applied:

- Before you commence operating the tester, acquaint yourself thoroughly with the present manual and observe the safety regulations and specifications determined by the manufacturer.
- Any application that differs from those specified in the present manual may result in a damage to the device and constitute a source of danger for the user.
- PAT-810/815/820 testers must be operated only by appropriately qualified personnel. Operating the tester by unauthorised personnel may result in damage to the device and constitute a source of danger for the user.
- Using this manual does not exclude the need to comply with occupational health and safety regulations and with other relevant fire regulations required during the performance of a particular type of work. Before starting the work with the device in special environments, e.g. potentially fire-risk/explosive environment, it is necessary to consult it with the person responsible for health and safety.
- It is forbidden to operate the following:
 - ⇒ A damaged tester which is completely or partially out of order,
 - ⇒ A tester with damaged test leads insulation,
 - ⇒ A tester stored for an excessive period of time in disadvantageous conditions (e.g. excessive humidity). If the tester has been transferred from a cool to a warm environment with a high-level of relative humidity, do not start measurements until the tester is warmed up to the ambient temperature (approximately 30 minutes).
- The tester may be powered only from grounded mains sockets.
- Before starting any measurement, make sure the test leads are connected to the proper test sockets.
- Do not touch the tested device during measurements.
- Test sockets and the socket for testing IEC cables are protected against improper connection to the voltage up to 300V AC for 60 seconds.
- Repairs may be carried out only by an authorised service point.

NOTE!

Only standard and additional accessories for a given device should be used, as listed in the "Equipment" section. Use of different accessories can lead to errors in the test connection and can introduce additional measurement uncertainties.

NOTE:

Due to continuous development of the tester's software, the actual appearance of the display, in case of some of the functions, may slightly differ from the display presented in this operating manual.

Note:

An attempt to install drivers in 64-bit Windows 8 may result in displaying "Installation failed" message.

Cause: Windows 8 by default blocks drivers without a digital signature.

Solution: Disable the driver signature enforcement in Windows.

2 General description and features of the instrument

PAT-810/815/820 digital testers are intended to measure the basic parameters of portable electrical devices (power tools, household appliances, etc.) important for their safety: protective conductor resistance, insulation resistance, continuity of connections, leakage current and RCDs.

The testers may be used to test equipment in accordance with the following standards:

- EN 60745-1 Hand-held motor-operated electric tools. Safety. Part 1: General requirements.
- EN 61029 Safety of transportable motor operated electric tools. General requirements.
- EN 60335-1 Household and similar electrical appliances. Safety. Part 1: General requirements.
- EN 60950 Information technology equipment – Safety- Part 1: General requirements.
- EN 61557-6 Electrical safety in low voltage distribution systems up to 1 000 V a.c. and 1 500 V d.c. - Equipment for testing, measuring or monitoring of protective measures - Part 6: Effectiveness of residual current devices (RCD) in TT, TN and IT systems.
- VDE 0404-1 Testing and Measuring Equipment for Checking the Electric Safety of Electric Devices - Part 1: General Requirements.
- VDE 0404-2 Testing and Measuring Equipment for Checking the Electric Safety of Electric Devices - Part 2: Testing Equipment for Tests after Repair, Change or in Case of Repeat Tests.
- VDE 0701-0702 Inspection after Repair, Modification of Electrical Appliances. Repeat Testing of Electrical Equipment. General Requirements for Electrical Safety.
- AS/NZS 3760:2010 In-service safety inspection and testing of electrical equipment.

Basic functions of the instrument:

Measurement of network voltage and frequency

Checking the resistance of L-N circuit

Measurement of protective conductor resistance (Protection class - I):

- technical measurement method
- measurement with sinusoidal current of network frequency and following currents: 200mA, 10A (only PAT-815/820) and 25 A (only PAT-815/820)
- adjustable measurement time
- adjustable upper limit in the range of: 10mΩ ...1.99Ω with 0.01Ω resolution

Measurement of insulation resistance:

- three test voltages: 100 V (only PAT-815/820), 250 V (only PAT-815/820) and 500 V
- measurement of insulation resistance up to 599 MΩ
- automatic discharge of the capacitance of tested object after the insulation resistance measurement is completed
- adjustable measurement time
- adjustable lower limit within the range of 0.19.9 MΩ with 0,1MΩ resolution

Flash test (only PAT-820)

- ❑ **Measurement of substitute leakage current::**
 - adjustable measurement time
 - adjustable upper limit in the range of: 0.01 ... 9.9 mA with 0.01mA/0.1mA resolution
- ❑ **Measurement of PE leakage current:**
 - adjustable measurement time
 - adjustable upper limit in the range of: 0.01 ... 9.9 mA with 0.01mA/0.1mA resolution
 - measurement of the current with clamp
- ❑ **Measurement of differential leakage current:**
 - adjustable measurement time
 - adjustable upper limit in the range of: 0.01 ... 9.9 mA with 0.01mA/0.1mA resolution
 - measurement of the current with clamp
- ❑ **Measurement of touch leakage current:**
 - adjustable measurement time
 - adjustable upper limit in the range of: 0.01 ... 1.99 mA with 0.01mA/0,1mA resolution
- ❑ **Measurement of Power**
 - P and S Power measurement
 - PF Power Factor measurement
- ❑ **Current consumption measurement**
 - Measurement with the PAT's internal measurement circuits or with clamp
- ❑ **Measurement of RCD's parameters**
 - $I_{\Delta n} = 10 \text{ mA}, 15 \text{ mA}, 30 \text{ mA}$
 - Measurement of I_A, t_A for 0,5 $I_{\Delta n}, 1 I_{\Delta n}, 2 I_{\Delta n}, 5 I_{\Delta n}$
- ❑ **IEC lead test**
- ❑ **Other:**
 - automatic selection of measuring range
 - tree structure of measurement results memory with provision of printing or transferring the results to PC via USB facilities
 - configurable with a bar-code scanner and printer
 - industrial computer equipped with large, readable, touch graphic display
 - PAT's power supply sustained for 15 minutes after disconnecting mains power supply with the use of built-in battery
 - ergonomic operation

3 Switching on and Main Menu

3.1 Power supply

The device is 195 V...265 V, 50 Hz mains powered.

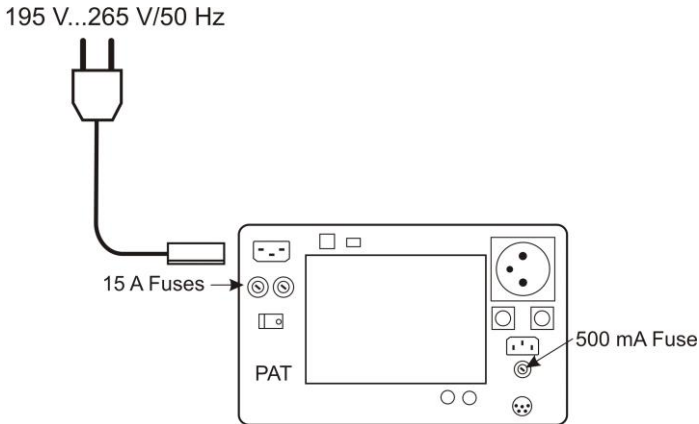

Two 15A fuses protect L and N lines from the supply socket to the test socket, they are tripped when current consumption from the test socket is too high (>16A).

500mA fuse protects 200mA current controller for R_{PE} measurement.

3.2 Start test after switching the tester on

After switching on, the tester performs a self-test to check its correct operational condition and when this test is successfully completed, the tester automatically performs the following measurements:

- measurement of the voltage in the power supply socket, i.e. the voltage between L and N of power supply to the tester,
- measurement of mains frequency,
- checking the continuity PE in the power supply socket,
- measuring the voltage between N and PE in the power supply socket,
- indicates swapped L and N terminals (icon on the screen).

Upon completing above mentioned measurements main Menu screen is displayed as below, along with the results of the measurements:

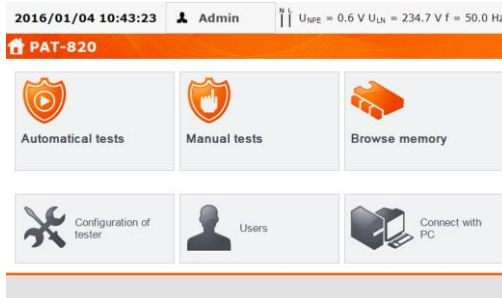

Note:

- For mains voltages below 195 V and above 256 V all test functions are automatically locked out.

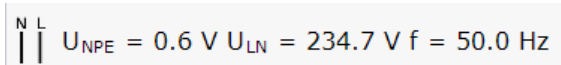

Additional information displayed on the screen

On the right upper corner of the screen mains network monitor is presented. It shows polarity of the power supply, voltage between N and PE, voltage between L and N, and mains frequency.



$U_{NPE} = 0.6 \text{ V}$ $U_{LN} = 234.7 \text{ V}$ $f = 50.0 \text{ Hz}$

Other information:

Dangerous voltage on PE	Voltage $U_{N-PE} > 25 \text{ V}$ or lack of PE continuity, measurements are blocked.
Note: Incorrect voltage of the supply. Switch on tester again with an audible signal	Mains voltage $> 265 \text{ V}$, measurements are blocked.
	Correct polarity of power supply (L i N), measurements possible.
	Uncorrect polarity of power supply, swapped L and N in the power supply socket of the tester. PAT automatically swaps L and N in the tester's test socket, and measurements are possible.

Note:

- Error message indicating incorrect voltage frequency may be caused by supplying power from an unstable voltage source (e.g. generator).

3.3 General settings – MENU

In the MENU the following actions are available:

- Auto tests,
- Manual tests,
- Browse memory,
- Configuration of tester:
 - Date and time: setting date and time,
 - Interface: swithing on/off audible signals and choice of language,
 - Tests: setting nominal mains voltage and additional options,
 - Printing: printing settings,
 - Specifications,
 - About tester and producer,
 - Firmware upgrade (update),
 - Service,
 - Network setting: Wi-Fi confoguration,
- List of users,
- PC connection.

Notes:

- Settings are saved and remembered after switching off the tester.
- **Auto tests**, **Manual tests** and **Browsing memory** are described in other chapters of this manual.

3.3.1 Symbols on screen



- go back to the main menu



- add new element (client, site, appliance), another measurement in multibox function



- save data (select device when saving to memory)



- opening Site or Appliance data



- deleting Site or Appliance



- moving Appliance into other Site



- move one level up



or  - previous screen (window)



or  - next screen



- close the window without saving changes



- searching (e.g. client, site, appliance)





- help



- editing data of the selected element (e.g. client, site, appliance)



or  - checkbox ,  mark inside the square means that the selected option is on or given content assigned to this field has been confirmed and is correct.



- commencing Auto test procedure



- connection with selected network WiFi (see sec.3.3.10)

Others:



S

- connect measurement probe to the object

ON



- appliance under test must be switched on



- NOTE: mains voltage in the measurement socket of the tester during the measurement. Appliance under test will switch on and go



- press START to start the test

READY!

- the tester is ready to commence the test

TEST IN PROGRESS

- test procedure is in progress

3.3.2 Setting date and time

1

Press **Configuration of tester**.

2

2016/01/08 14:13:45 Admin U_{HPZ} = 0.5 V U_{LV} = 236.9 V f = 50.0 Hz

Configuration of tester

Date and time	Specifications	Network setting
Interface	About tester and producer	
Test	Update	
Prints	Service	

Home icon

Press **Date and Time**.

3

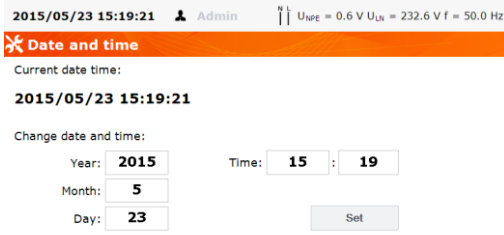

Press the field you intend to change.

4

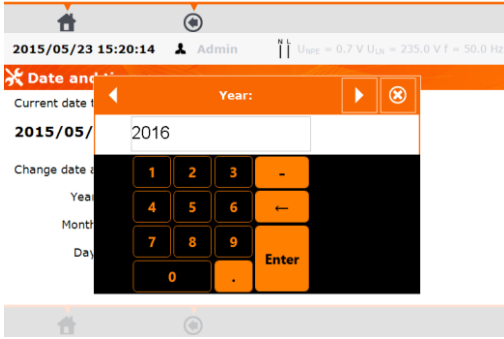

In the date edit window type in proper value and press **Enter** to proceed to editing next parameter or press **Enter** to save changes and close the window.

5

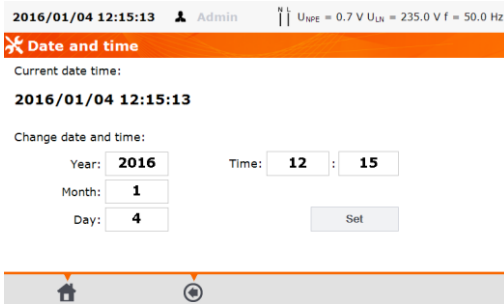

After entering new values press **Set** to confirm the date and time settings.

3.3.3 Interface settings

1 Press **Configuration of tester**.

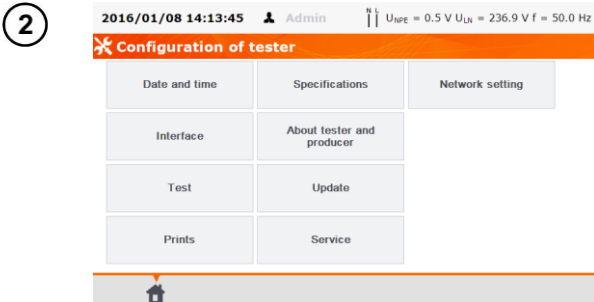

Press **Interface**.

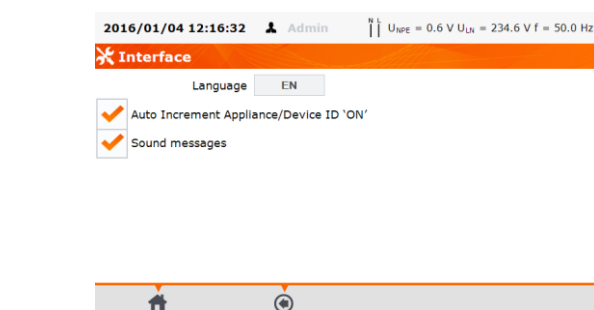

Pressing square **Auto Increment Appliance/Device ID 'ON'** turn on or off automatic incrementing of the registration number assigned to the next added device. Pressing square **Sound messages** turn on or off sound signals.

Pressing **Language** go to the choice of language.

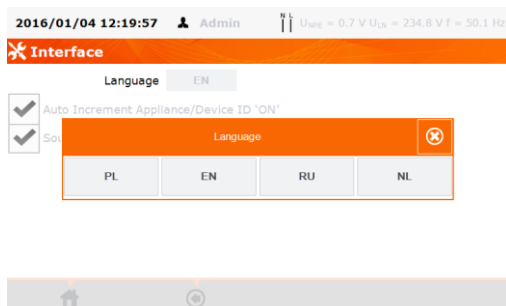

3.3.4 Measurement settings

1 Press **Configuration of tester**.

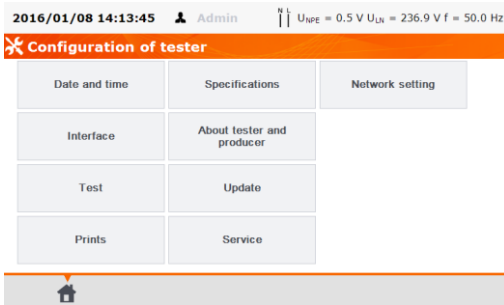

Press **Test**.

3

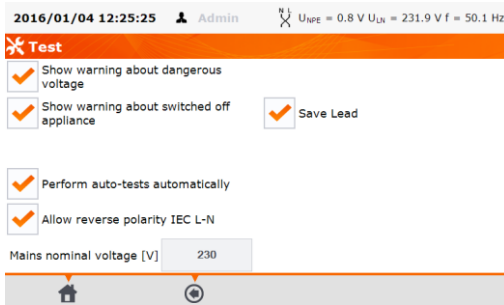

Select chosen options by ticking empty squares. Press **Mains nominal voltage [V]: 220/230/240**, to change nominal network voltage powering the tester.

4

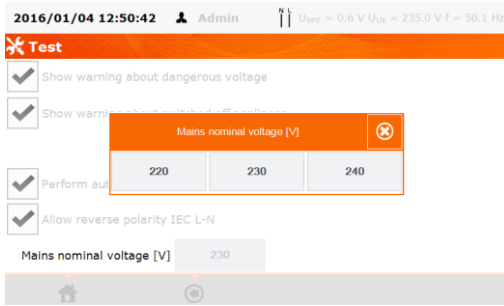

Select the proper voltage, and close the window.

Notes:

- Warnings:

Show warning about dangerous voltage – switch on/off warnings about the possibility of the voltage being dangerous to user that may appear during tests.

Show warning about switched off appliance – switch on/off notification that the tested device is not connected or it's not turned on.

Warn about the possibility of losing unsaved results – switch on/off warning indicating possible loss of unsaved data, e.g. when the user is closing windows filled with data without saving changes.

Note: It is advised for less experienced users to keep all the above warnings on.

- Auto-tests:

Perform auto-tests automatically – switch on/off automatic mode of performing autotests, which is performing the complete set of autotests after single press of **START** button.

- Polarity IEC L-N:

Allow reverse polarity IEC L-N – allows interchanging of L and N lines in the tested IEC conductor, the test result is displayed as positive.

- Power cord for the device:

Save lead – after ticking this box, the power cord is saved in the memory and printed on a printout as a separate device, otherwise it is considered as an integral part of the device.

3.3.5 Printing

① Press **Configuration of tester**.

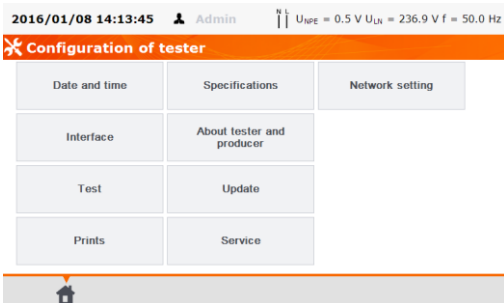

Press **Print**.

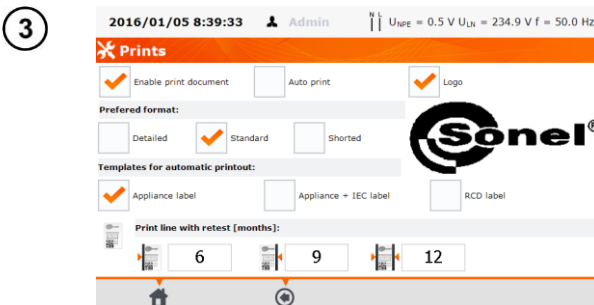

Select chosen options by tick-
ing empty squares.

Notes:

Enable print document – enable/disable printer.

Auto print: – printing automatically after the test is finished.

Logo – placing SONEL logo on the print-out.

Preferred format:

Detailed – contains a list of questions of the visual examination together with the assessment and the results of individual measurements with the assessment.

Standard – includes overall result of the test, logos and additional data (name of the device, measuring person).

Shorted – similar to standard format but without the logo and additional information.

Templates for automatic printout:

Appliance label – label with a test result of an appliance.

Appliance + IEC label – label with a test result of an appliance and IEC power cord.

RCD label – label with an RCD test result.

Print line with retest [months]: – Printing stripe on the left, right, or both sides of the label, depending on the number of the months, after which retest of the appliance must be done. The number of months is selected by clicking on proper field, similarly to setting date and time.

3.3.6 PAT specifications

① Press **Configuration of tester**.

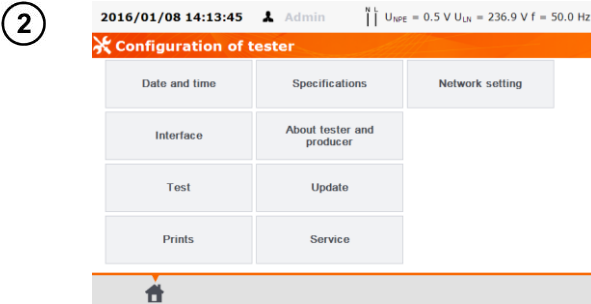

Press **Specifications**.

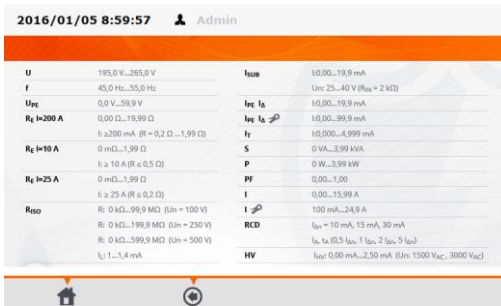

A window with general measurement parameters of the tester will be displayed. Detailed parameters are listed in the PAT Operating Manual.

3.3.7 Firmware upgrade

In order to upgrade the PAT's firmware, new firmware has to be downloaded from www.sonel.pl/en website. The new firmware file has to be uploaded into USB flash drive. It is advised to copy all the data from the tester's memory before starting upgrading procedure, to avoid accidental memory erase.

1

Press **Configuration of tester**.

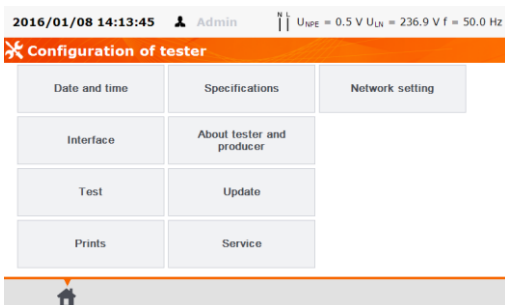

Press **Update**.

2

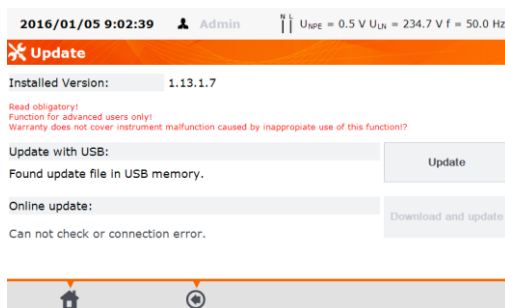

Read the warning message. To perform an update insert the USB drive with the update files and click **Update** or ensure Internet connection of the meter via WiFi, and click **Download and update**.

3

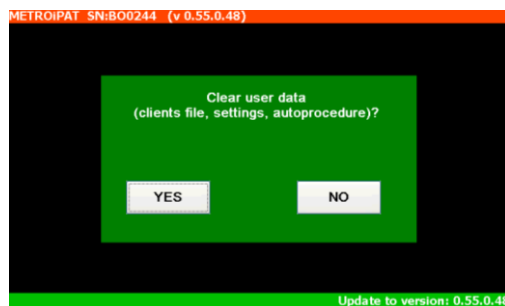

Press **YES** only if the upgrade asks for it, as all data stored in the memory will be erased, along with all user settings. In most cases user should press **NO**.

4

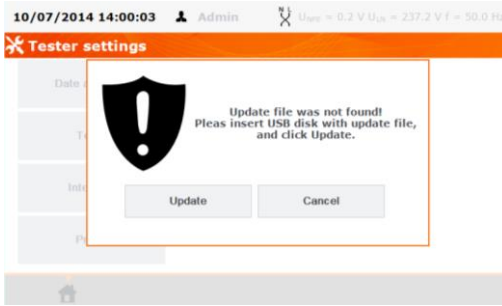

This screen shows up only when USB flash drive is not inserted or it's not detected/proper. Insert USB flash disk with upgrade files on it and press **Update** to upgrade the firmware or press **Cancel** to cancel upgrading procedure.

Note:

- Firmware upgrade is preformed automatically and can be completed in several stages. During the upgrade procedure it is not allowed both to switch off the tester's power supply and to remove USB flash drive. Once the upgrade is completed it will be confirmed by the below message.

5

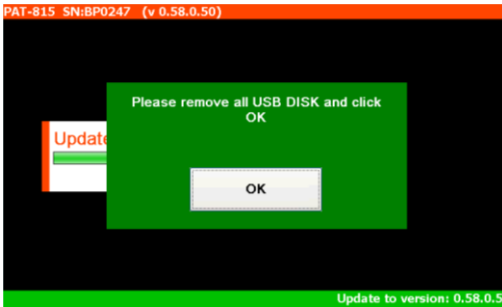

Remove USB flash disk and press **OK** to complete the upgrade procedure.

Note:

- Upon completing this operation the tester will reset. It is not allowed to swith off the tester's power supply at this stage. The upgrading/configuring changes process is continued and will last until main MENU screen comes up.

6

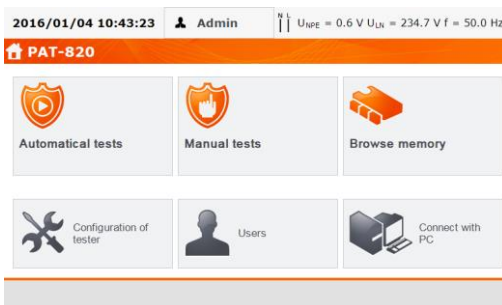

Only at this stage it is allowed to switch off the power supply or to start using the tester.

3.3.8 Information about tester and producer

1 Press **Configuration of tester**.

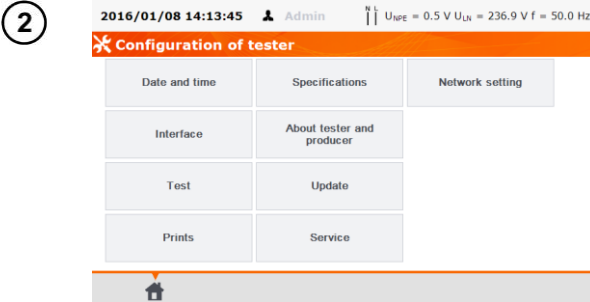

Press **About tester and producer**.



The tester data and the producer information window.

3.3.9 Service

This function is available solely for service and protected with the password.

3.3.10 Network setting

Note: LAN may be available in devices copies on request.

1 Press **Configuration of tester**.

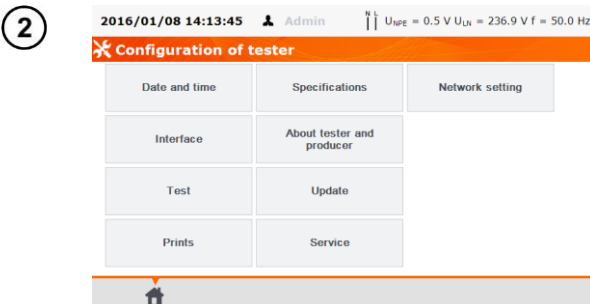

Press **Network setting**.

3

2014/11/19 9:48:51 Admin U_{HP} = 0.6 V U_{LN} = 235.5 V f = 50.0 Hz

WiFi configuration

Connection information **WiFi disconnected** Disable

Available networks

Preferred network

LAN

Home Add

To get information about local active networks WiFi press **Available networks**.

4

2014/11/19 9:51:05 Admin U_{HP} = 0.6 V U_{LN} = 235.6 V f = 50.0 Hz

WiFi configuration

Connection information WBK Security-enabled wireless network: WPA2PSK

Available networks

Preferred network

LAN

Home Add

A network requiring the password was found.

5

2014/11/19 9:52:18 Admin U_{HP} = 0.6 V U_{LN} = 236.2 V f = 50.0 Hz

WiFi configuration

Connection information WBK Security-enabled wireless network: WPA2PSK

Available networks

Preferred network

LAN

Home Add +

To add to the memory found-network press (select) the name of the network and press **+** (Add).

6

2014/11/19 9:53:37 Admin U_{HP} = 0.6 V U_{LN} = 236.5 V f = 50.0 Hz

Edit preferred network

Network SSID: WBK

Security: WPA2PSK

Password:

Home Add Save

Press field **Password:**, type password required for this network and press **Save** (Save).

7

2014/11/19 10:00:33 Admin $U_{NPE} = 0.6 V$ $U_{LH} = 238.3 V$ $f = 50.0 Hz$

WiFi configuration

Connection information	WiFi connected	Disable
General		
Available networks	Network name: WBK Interface MAC: 00:1B:CS:0B:21:67 Speed: 54 Mb/s Security: WPA2PSK Infrastructure: Infrastructure	
Preferred network	IP configuration: DHCP: True IP Address: 192.168.100.146 Access point MAC: 00:22:6B:8D:F3:ED Subnet Mask: 255.255.0 Default Gateway: 192.168.100.1 DHCP Server: 192.168.100.1	

LAN

The network is saved and connected with the tester, connection's parameters are available. The button **On/Off** on the right turns on or off the WiFi module in the tester.

8

2014/11/19 9:57:16 Admin $U_{NPE} = 0.6 V$ $U_{LH} = 237.1 V$ $f = 50.1 Hz$

WiFi configuration

Connection information	<input checked="" type="checkbox"/> WBK Security-enabled wireless network: WPA2PSK
Available networks	MWS Security-enabled wireless network: WPA2PSK
Preferred network	SSA1B Security-enabled wireless network: WPA2PSK

LAN

Pressing **Preferred network** enables displaying networks saved already in the tester. The network selected with is the network currently connected with the tester.

9

2014/11/19 9:58:40 Admin $U_{NPE} = 0.7 V$ $U_{LH} = 237.9 V$ $f = 50.1 Hz$

WiFi configuration

Connection information	<input checked="" type="checkbox"/> WBK Security-enabled wireless network: WPA2PSK
Available networks	MWS Security-enabled wireless network: WPA2PSK
Preferred network	SSA1B Security-enabled wireless network: WPA2PSK

LAN

Pressing (selecting) the network's name allows:

10

2014/11/19 9:57:16 Admin $U_{NPE} = 0.6 V$ $U_{LH} = 237.1 V$ $f = 50.1 Hz$

WiFi configuration

Connection information	<input type="checkbox"/> WBK Security-enabled wireless network: WPA2PSK
Available networks	<input checked="" type="checkbox"/> MWS Security-enabled wireless network: WPA2PSK
Preferred network	SSA1B Security-enabled wireless network: WPA2PSK

LAN

with the button  (**Connect**) – connection with the selected network (provided it is active on this territory),

11

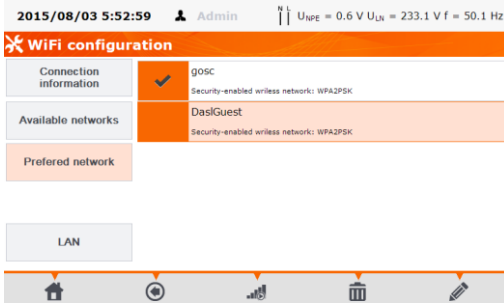

with the button  (**Delete**) – removal of selected network,

12



with the button  (**Edit**) – changing of the password.

3.3.11 List of Users

1

Press **Users**.

Users are introduced to signing test's performers. The tester can be used by many people. Each person can log in with his own login and password. Passwords are introduced to prevent the signing of the test someone else's name. Only Administrator can add and delete users. Others can only change their own data.

Test results stored in tester's memory are tagged with user names, indicating users who were logged in while performing tests. Additionally, the names appear on labels, which helps to identify the person who was performing tests.

2

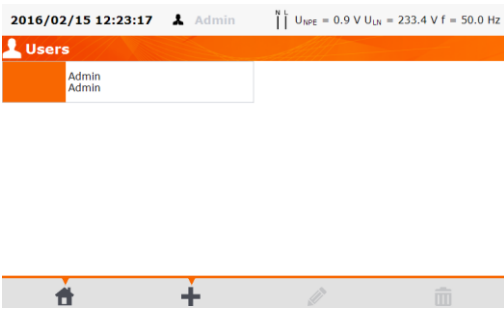

To add a User press .

3

2016/02/15 12:24:09 Admin U_{AGE} = 0.9 V U_{LY} = 234.8 V f = 50.1 Hz

Add user

Login

Firstname and Surname

Use password

Password

Repeat password

Press within the blank field to bring up the keyboard (as on the screen below), which allows to enter login, first name and surname and, after selecting **Use Password**, user can secure the access to the new account with a password. Fields marked with orange frame are mandatory.

4

2016/02/15 12:27:17 Admin U_{AGE} = 0.9 V U_{LY} = 234.8 V f = 50.1 Hz

Login

1 2 3 4 5 6 7 8 9 0 - =

q w e r t y u i o p []

a s d f g h j k l ; \ ←

ABC z x c v b n m , . / Enter

ALT

Press  to proceed to next blank input data field without disabling the keyboard.

5

2016/02/15 12:28:45 Admin U_{AGE} = 1.0 V U_{LY} = 235.2 V f = 50.1 Hz

Add user

Login

Firstname and Surname

Use password

Password



Repeat password



Confirm by pressing  **Save.**

6

2016/02/15 12:29:56 Admin U_{AGE} = 1.0 V U_{LY} = 234.6 V f = 50.0 Hz

Users

	Admin Admin
	jsmit John Smith

The padlock symbol means that the user is protected by a password.
To change User's data press  **Edit.**
To delete User's data press  **Delete.**

Note:

- PAT remembers the last user if he/she is not protected by the password.

①

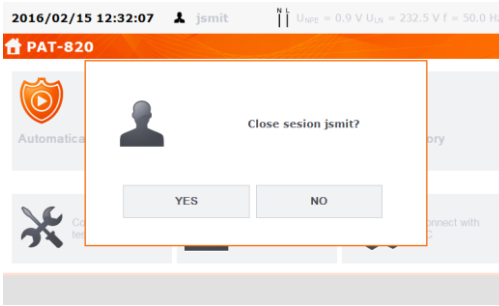

To change user, the current one has to log out. Press his name on the top of the screen in the main menu and then press **YES** to confirm.

②

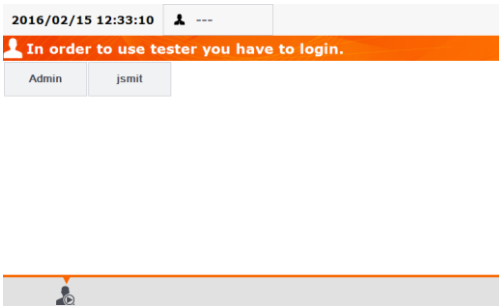

3.3.12 Memory structure (Clients, Objects, Subobjects and Appliances)

3.3.12.1 Adding Clients

①

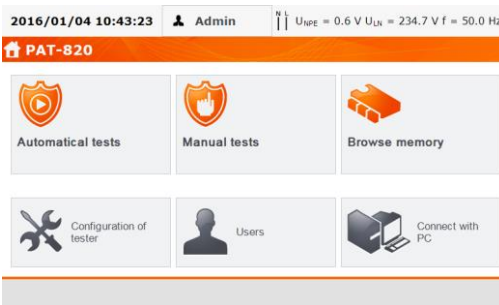

Press **Browse memory**.

2

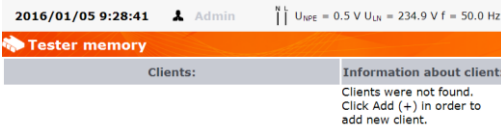

To add new client press **+** (Add).

3

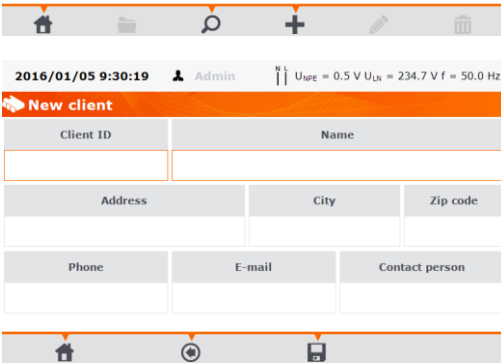

Press each field and enter client's data with on-screen keyboard. Filling data marked with orange frame is mandatory.

4



Press **▶**, **◀** to toggle between next and previous data field without disabling the keyboard. After entering all data confirm the changes by pressing **Enter**. Press **⊗** to close the window without saving changes.

5

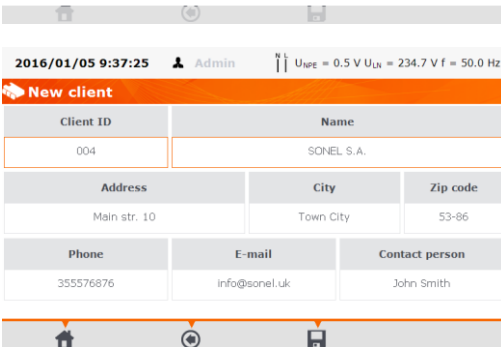

Press **Save** (Save) to save client's data.

6

2016/01/05 9:38:35 Admin U_{HP} = 0.5 V U_{LN} = 234.8 V f = 50.0 Hz

Tester memory

Clients:		Information about client:
004	SONEL S.A. client_4.client	Client ID: 004 Name: SONEL S.A. Address: Main str. 10 53-86 Town City Phone: 355576876 E-mail: info@sonel.uk Contact person:John Smith

Home, Trash, Search, Add, Edit, Delete

New client has been added.
To change client's data press  (Edit).

3.3.12.2 Adding Objects.

1

2016/01/05 9:39:57 Admin U_{HP} = 0.5 V U_{LN} = 233.5 V f = 50.0 Hz

Tester memory

Clients:		Information about client:
004	SONEL S.A. client_4.client	Client ID: 004 Name: SONEL S.A. Address: Main str. 10 53-86 Town City Phone: 355576876 E-mail: info@sonel.uk Contact person:John Smith

Home, Trash, Search, Add, Edit, Delete

To add new object or appliance press client's name and press  (Open) or double-press client's or object's name to add subobject within the selected object.

2

2016/01/05 9:42:30 Admin U_{HP} = 0.8 V U_{LN} = 233.4 V f = 50.0 Hz

004

Objects	Appliance

Home, Add, Trash, Search, Edit, Delete

To add new object or appliance press  (Add).

3

2016/01/05 9:43:07 Admin U_{HP} = 0.7 V U_{LN} = 233.2 V f = 50.0 Hz

004

Objects	Appliance

Add new ✕

Add new object	Add new appliance
----------------	-------------------

Home, Add, Trash, Search, Edit, Delete

For adding new object press **Add new object**.

4

2016/01/05 9:49:51 Admin $U_{NPE} = 0.5 \text{ V}$ $U_{LN} = 235.3 \text{ V}$ $f = 50.0 \text{ Hz}$

Edit

Object ID		
Building 1		
Address	Zip code	City
Wokulskiego 11	51-100	Swidnica
E-mail	Phone	Contact person
building1@sonel.pl	334861238	Karol Nowak

Home Add Edit Delete Search

Enter object's data in the same way as when entering client's data. Filling data marked with orange frame is mandatory. Press  (**Save**) to save object's data.



5

2016/01/05 9:51:20 Admin $U_{NPE} = 0.5 \text{ V}$ $U_{LN} = 234.8 \text{ V}$ $f = 50.0 \text{ Hz}$

004

Objects	Appliance
Building 1	

Home Add Edit Delete Search

New object has been added. To change object's data press  (**Edit**). To add subobject or appliance within the added already object (lower level) press the object's name and  (**Open**) or double-press the object's name.

6

2016/01/05 9:52:41 Admin $U_{NPE} = 0.5 \text{ V}$ $U_{LN} = 235.4 \text{ V}$ $f = 50.0 \text{ Hz}$

004 \ Building 1

Objects	Appliance

Home Add Edit Delete Search

Press  (**Add**) and proceed in the same way as when adding previous objects.

7

2016/01/05 9:55:09 Admin $U_{NPE} = 0.5 \text{ V}$ $U_{LN} = 235.0 \text{ V}$ $f = 50.0 \text{ Hz}$

004 \ Building 1

Objects	Appliance
Room 1	

Home Add Edit Delete Search

Subobject **Room 1** within the object **Building 1**. To add next subobject within the subobject **Room 1**, open the subobject and proceed as described before.

Notes:

- Objects and subobjects (objects within objects) can be incremented up to 5 levels, starting from client.
- Memory structure can be expanded on each level.

3.3.12.3 Adding Appliances.

Note:

- Appliances can be assigned (added) directly to clients or to separate objects and subobjects of given client.

1

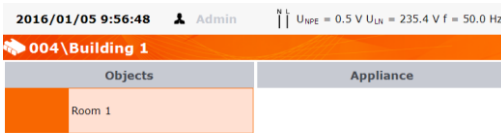

To add appliance press **+** (Add).

2

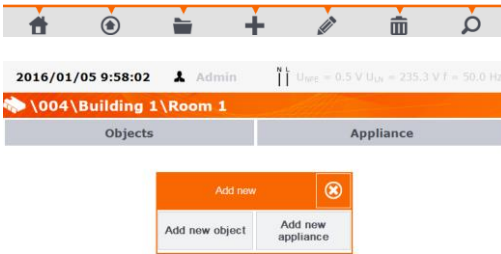

When adding new appliance press **Add new appliance**.

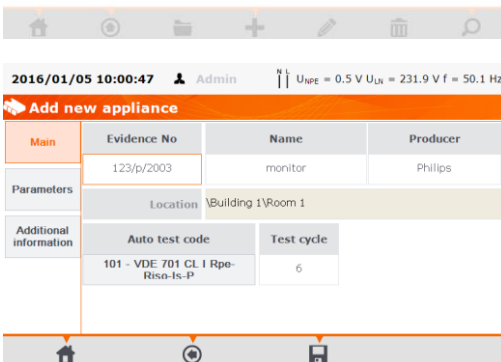

3

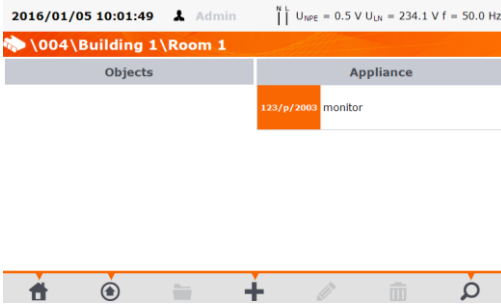

Enter (type) appliance's data in the same way as for the client or object. Filling data marked with orange frame is mandatory. Additional data is available under **Parameters** and **Additional information**. Press **Save** (Save) to save the appliance's data.

4



A new appliance has been added. To change the appliance's data press the appliance's name and then  (**Edit**). To add another appliance within the same object press  (**Add**).

Note:

- The number of the appliances to be added is not limited by the firmware, and the only limitation derives from the tester's memory capacity.

3.3.12.4 Deleting clients, objects and appliances.

1

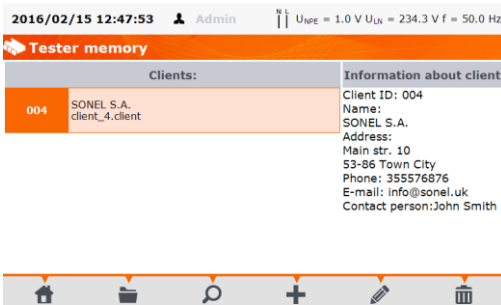

To delete client, object or appliance, make your selection and press  (**Delete**).

2

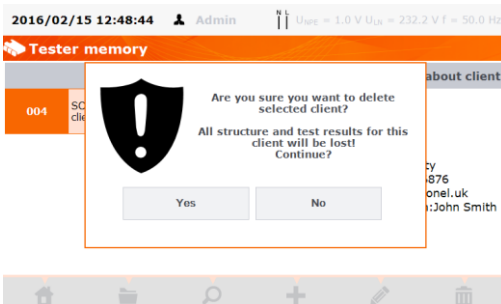

Read the message and confirm deleting selected item by pressing **Yes** or cancel by pressing **No**.

Note:



Deleting client or object also deletes all subobjects, appliances and measurement results linked to them.

3.3.13 Communication with PC

With the use of “Sonel Analysis” PC program, the same settings, as within the tester, can be done. Additionally, in ‘Sonel Analysis’, user can:

- move data from tester to PC, and from PC to tester,
- program user editable auto tests,
- fully manage clients and their test results,
- change PAT settings.

1

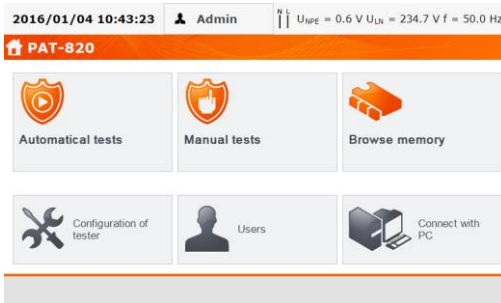

Press **Connect with PC**.

2

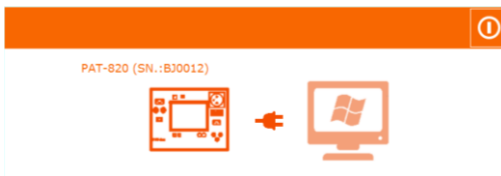

Start “Sonel Analysis” programme. To disconnect PAT from PC software press .

4 Measurements

Notes:



The socket marked with  symbol is connected with the PE pin of the test socket. It is not allowed to apply dangerous voltage to this socket.

- Tested appliance must be turned on.
- Continuous measurement lasts until **STOP** is pressed.
- After completing each measurement its parameters, date and duration of the measurement can be viewed.

4.1 Preliminary test

1

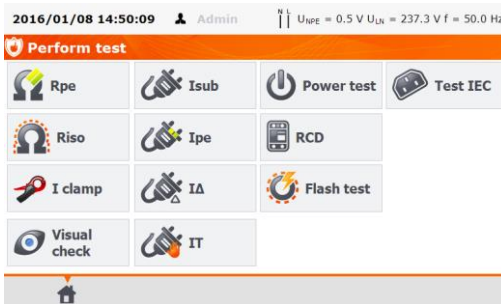

Press **Visual check**.

2

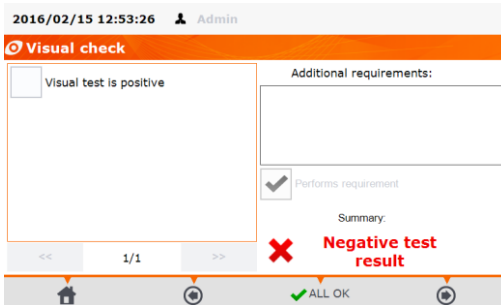

Examine the power cord and the mains plug for cracks and overheated spots. Place the fuse to the test fields. The efficiency of the fuse is indicated by displaying fuse symbol and a sound signal.

3

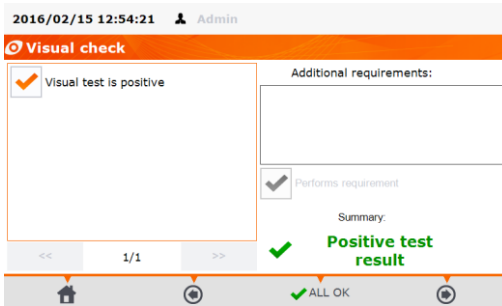

If everything is in order select square **Visual test is positive** or press **All OK**.

4

Connect the mains plug of the tested appliance into the test socket of the tester.

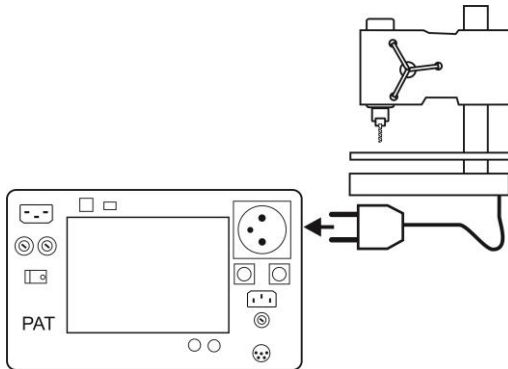

Notes:

- Tested appliance must be turned on.
- R_{L-N} measurement is intended for resistance objects, in case of inductive objects, the result may be burdened with an additional errors.
- R_{L-N} test is conducted every time before any measurement is commenced and it verifies whether or not the tested device is properly connected and turned on. The criteria applied is $R_{L-N} < 5k\Omega$. Therefore, for some devices, warning note may appear saying that the proper connection has not been established, even though it has.

4.2 Measurement of PE resistance

1

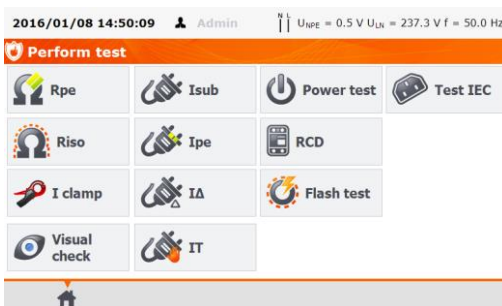

Press **Rpe**.

Before the measurement the following has to be set:

2

Test current – select one of the values on screen,

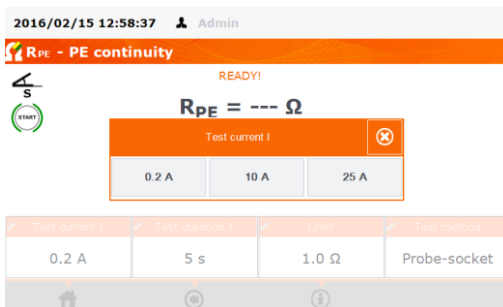

3

Test duration - use slider or +/- buttons, or select **Continuous test (∞)** checkbox (which will make the test last until **STOP** is pressed), confirm by pressing **OK**,

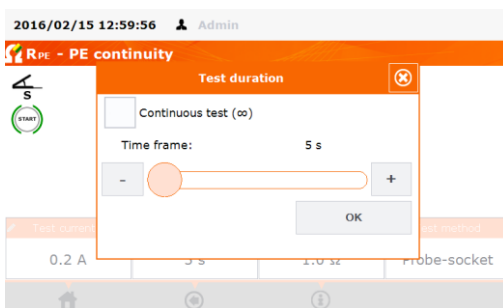

Notes:

- Continuous test is not available for 10 A and 25 A.
- For PAT-810 only 0.2 A current is available.

4

PE cable length - use keyboard to enter the length or enter upper limit of R_{PE} resistance - preset values can also be selected,

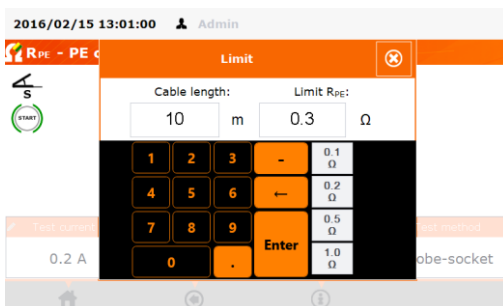

5

- Test method:
- **Test probe socket (3-pole method),**
 - **Probe to probe (4-pole method),**
 - **IEC.**

Test probe socket:

6

Connect mains plug of the appliance under test into test socket of the tester. Use the probe

connected to socket **T2** and touch metal parts of the tested device connected to PE.

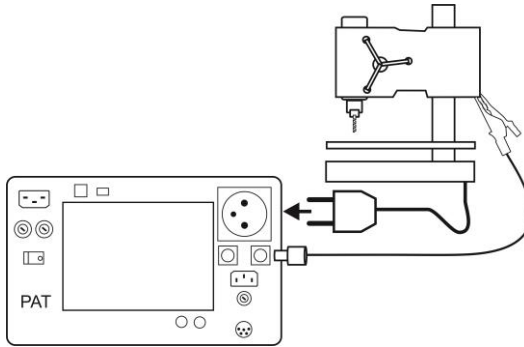

Probe to probe:

- 6 Connect PE of the tested device's mains plug into **T1** terminal socket. Use the probe connected to socket **T2** and touch metal parts of the tested device connected to PE.

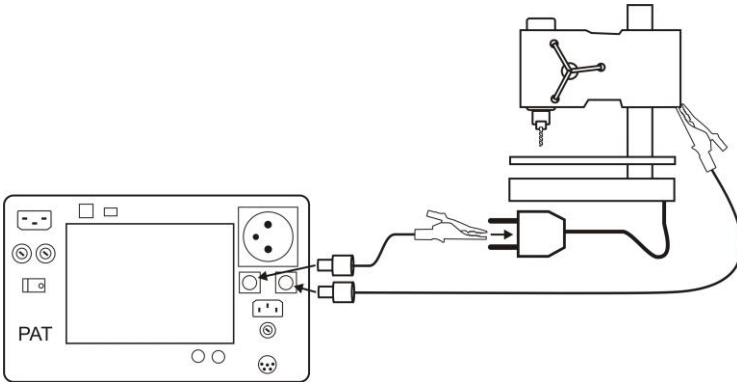

IEC power cord:

- 6 Connect mains plug of the power cord into test socket, and connect the other end into IEC socket.

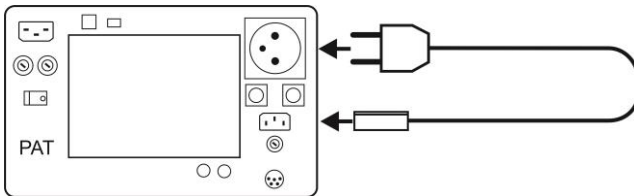

7



Press **START**.
Upon completing the measurement read the result. The test can be finished before the defined test time duration by pressing **STOP**.

2016/02/15 13:03:10 Admin

R_{PE} - PE continuity

READY!

R_{PE} = 0.07 Ω

2016/02/15 13:02:56
Positive test result

Test current I	Test duration t	Limit	Test method
0.2 A	5 s	0.3 Ω	Probe-socket

Positive test result: $R_{PE} < LIMIT$

2016/02/15 13:04:24 Admin

R_{PE} - PE continuity

READY!

R_{PE} > 19.99 Ω

2016/02/15 13:04:10
Negative test result

Test current I	Test duration t	Limit	Test method
0.2 A	5 s	0.3 Ω	Probe-socket

Negative test result: $R_{PE} > LIMIT$

Notes:

- Test circuit is electrically isolated from the mains and from mains' PE lead.
- Continuous test is available only for 200mA test current.

4.3 Measurement of insulation resistance

Note:

- For Class I appliances, the previous R_{PE} test has to have positive result.

1

2016/01/08 14:50:09 Admin $U_{RPE} = 0.5 V U_{LX} = 237.3 V f = 50.0 Hz$

Perform test

Rpe	Isub	Power test	Test IEC
Riso	Ipe	RCD	
I clamp	IΔ	Flash test	
Visual check	IT		

Press **Riso**.

Before starting the measurement, similarly to the measurement of PE continuity test (see 4.2 of this manual), following parameters must be set: **test voltage**, **test duration**, **limit** and measurement method: **Socket** (measurement between shorted L-N and PE of the test socket or T2 probe), **Probe-probe** (measurement between T1 and T2 probes) or **IEC** (IEC cord test).

Notes:

- Tested device must be turned on.
- Test circuit is electrically isolated from the mains and from mains' PE lead.
- Test result should be read only after displayed values are stabilised.
- After the measurement the tested object is automatically discharged.

4.3.1 Measurement of R_{ISO} on Class I devices

- 1 Connect the mains plug of the tested appliance into the test socket of the tester. The measurement is made between shorted L, N and PE. Additionally, there is possibility to carry out the measurement with the probe connected to **T2** terminal socket.

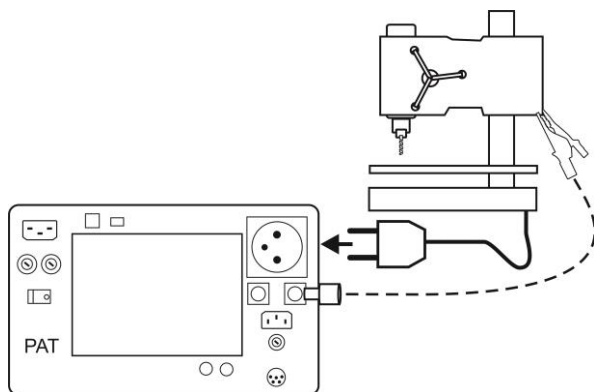

2



Press **START**.
After the measurement is completed, read the result. The measurement ends after a preset time runs out or by pressing **STOP**.

2016/02/15 13:07:06 Admin

R_{ISO} - Insulation resistance

READY!

✓ **$R_{ISO} > 599.9 \text{ M}\Omega$**

2016/02/15 13:06:48
Positive test result

Test voltage U_{ISO}	Test duration t	Limit	Test method
500 V	10 s	10 M Ω	Probe-socket

Positive test result: $R_{ISO} > \text{LIMIT}$

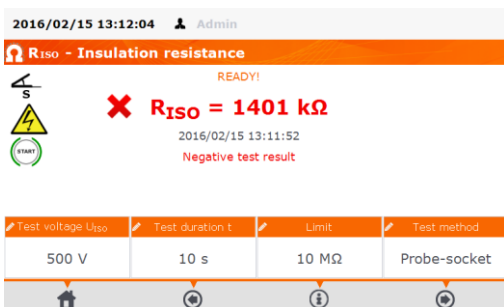

Negative test result: R_{ISO} < LIMIT

Note:

- Before the measurement (also in AUTO test) check the resistance of the protective conductor R_{PE}, which should be correct.

4.3.2 Measurement without using the test socket

Connect shorted L and N of the mains plug of the tested device to **T1** terminal socket. Use the probe connected to **T2** terminal socket and touch the conductive accessible parts of the tested device.

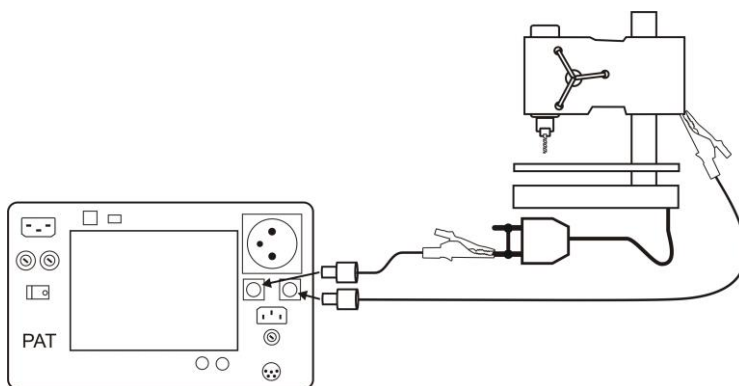

The measurement procedure is similar to the one described in 4.3.1.

4.3.3 Measurement of R_{ISO} on Class II (III) devices

Connect the mains plug of the tested device into the test socket of the tester. L and N are shorted. Use the probe connected to **T2** terminal socket and touch the conductive accessible parts of the tested device.

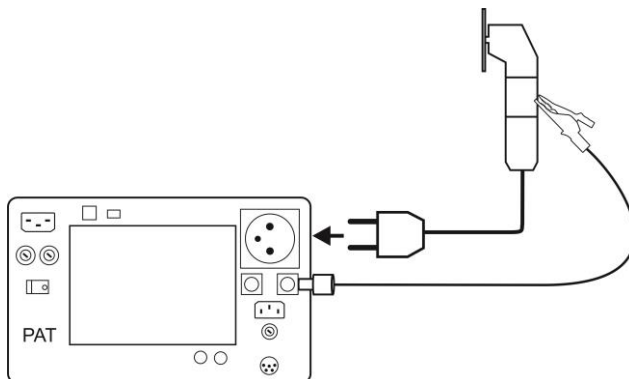

The measurement procedure is similar to the one described in 4.3.1.

4.3.4 R_{ISO} measurement of IEC power cord

Connect mains plug of the power cord into test socket, and connect the other end into IEC socket.

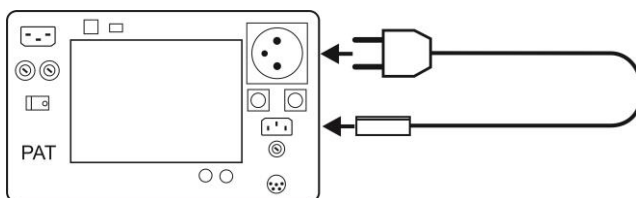

The measurement procedure is similar to the one described in 4.3.1.

4.4 Durability of insulation (flash test) – only PAT-820

The meter measures the current flowing during the test and displays its value checking whether it falls within the preset limit. Solely the appliance of class I and II can be tested.

①

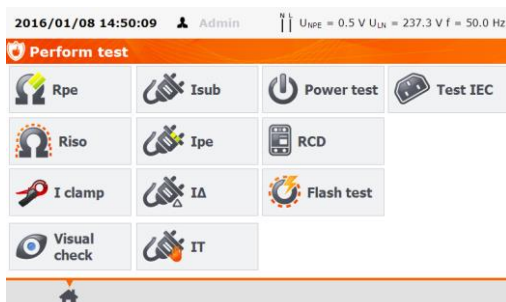

Press **Flash test**.

Before measurement, similarly to the measurement of insulation resistance (see sec. 4.3), following parameters must be set: **test voltage** (1500 V lub 3000 V), **test duration** and **limit**.

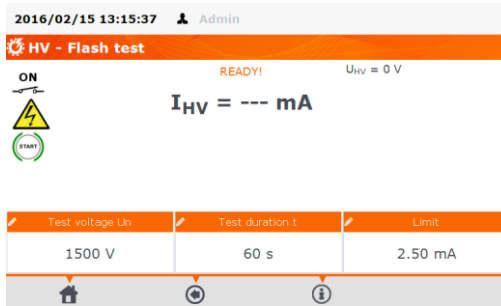

4.4.1 Measurement on Class I devices

- 1 The test voltage is drawn between the sockets **HV1** and **HV2**. It should be connected between the L and N shorted together, and PE.

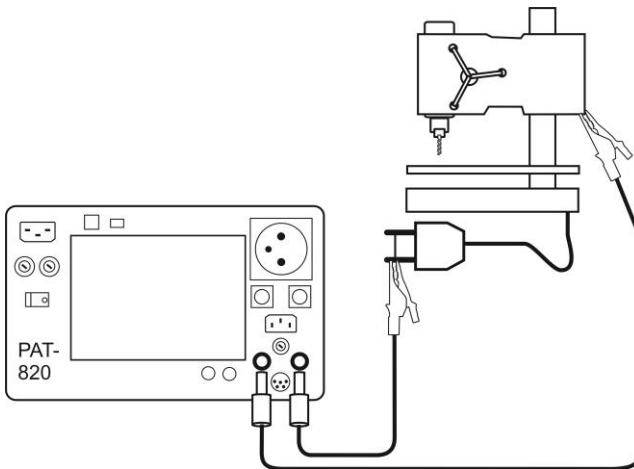

2



Press **START**.
After the measurement is completed, read the result. The measurement ends after a preset time runs out or by pressing **STOP**.

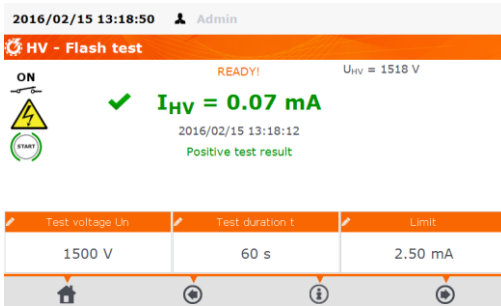

Positive test result: $I_{HV} < \text{LIMIT}$

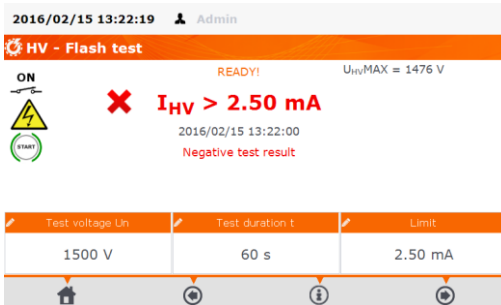

Negative test result: $I_{HV} > \text{LIMIT}$

4.4.2 Measurement on Class II devices

The test voltage is drawn between the sockets **HV1** and **HV2**. It should be connected between the L and N shorted together, and conductive available part of the appliance.

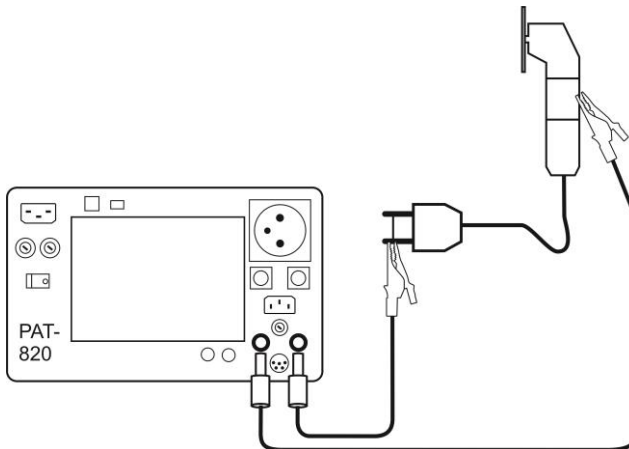

The measurement procedure is similar to the one described in 4.4.1.

4.5 Measurement of substitute leakage current

Notes:

- For Class I appliances, the previous R_{PE} test has to have positive result.
- I_{SUB} current is measured at <50 V voltage and its value is rescaled to the nominal mains voltage value set in the menu (see 3.3.5). The voltage is applied between shorted L ad N, and PE. The resistance of the measuring circuit is $2k\Omega$.

1

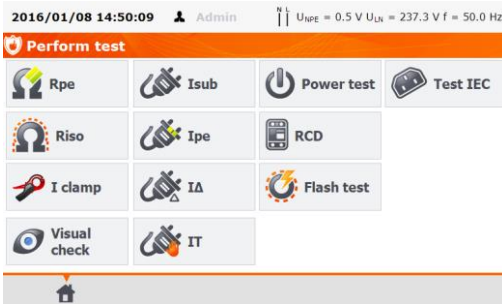

Press **Isub**.

Before starting the measurement, similarly to the measurement of PE continuity test (see 4.2 of this manual), following parameters must be set: **test duration**, **limit**.

2

For Class I, connect the mains plug of the tested appliance into the test socket of the tester.

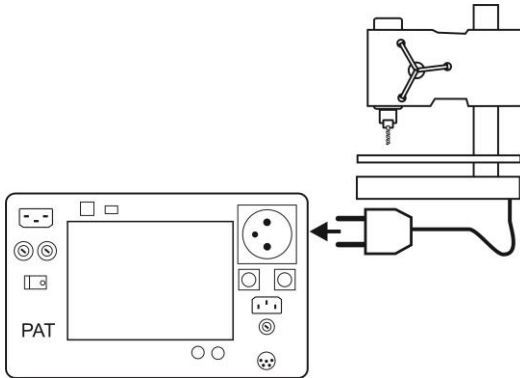

3

For Class II and accessible parts disconnected from PE in Class I, connect the probe to **T2** terminal socket and touch the accessible parts of the tested device.

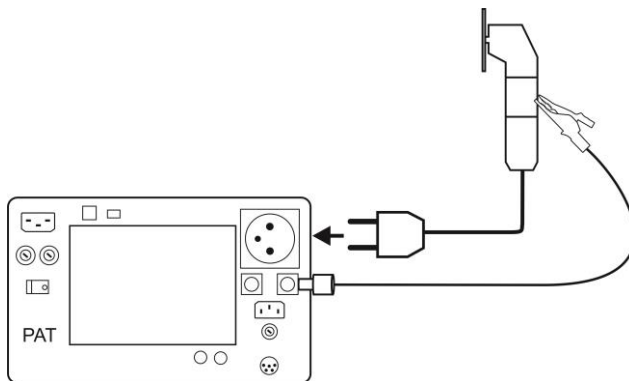

4



Press **START**.

Upon completing the measurement, read the result. The test can be finished before the defined test time duration by pressing **STOP**.

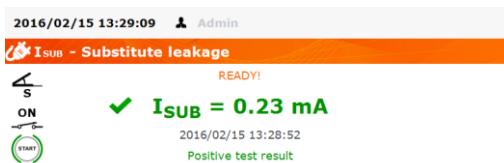

Positive test result: $I_{SUB} < LIMIT$



Negative test result: $I_{SUB} > LIMIT$



Notes:

- Tested device must be turned on.
- Test circuit is electrically isolated from the mains and from mains' PE lead.
- Test voltage is 25 V...50 V rms

4.6 Measurement of PE leakage current

Note:

- This measurement makes sense only in case when R_{PE} test had positive result.

①

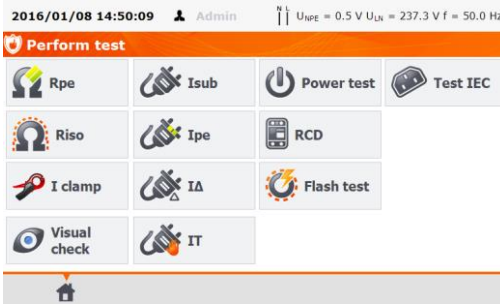

Press Ipe.

Before starting the measurement, similarly to the measurement of PE resistance test (see 4.2 of this manual), following parameters must be set: **test duration, limit** and:

②

in **Use clamp** select **YES**, if clamp is to be used for the measurement, or **NO** if the test is to be performed in test socket of the tester. In **Change polarity** select **YES**, if the measurement is to be repeated for reverse polarity or **NO**, if the measurement is performed for only one polarity.

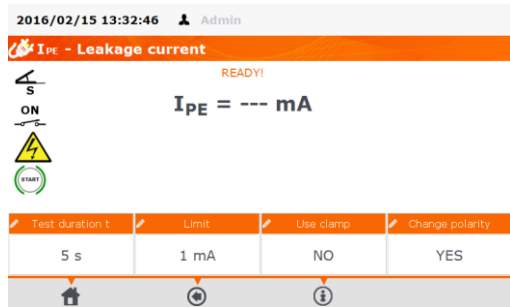

Measurement without clamp:

③

Connect the mains plug of the tested appliance into the test socket of the tester. Additionally, it is possible to carry out the measurement with the probe connected to **T1** terminal socket.

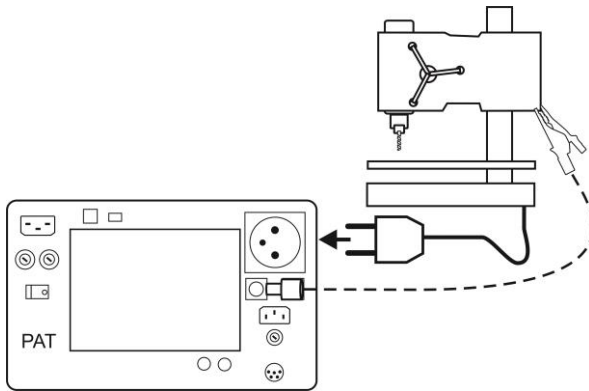

Measurement with clamp:

- 3 Attach clamp around PE conductor.

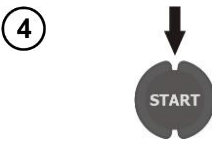
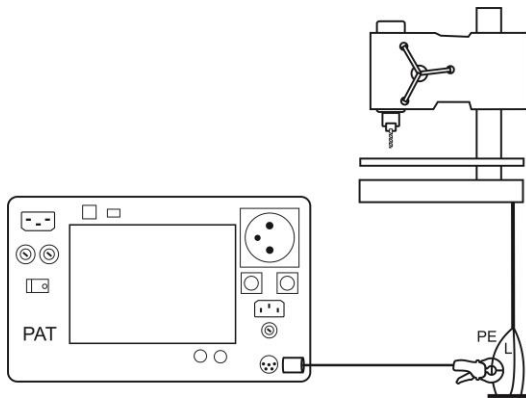

Press **START**.
Upon completing the measurement read the result. The test can be finished before the defined test time duration by pressing **STOP**.

2016/02/15 13:36:14 Admin

I_{PE} - Leakage current

READY!

✓ **I_{PE} = 0.27 mA**

2016/02/15 13:35:57
Positive test result

Test duration t	Limit	Use clamp	Change polarity
5 s	1 mA	NO	YES

Positive test result: I_{PE} < LIMIT

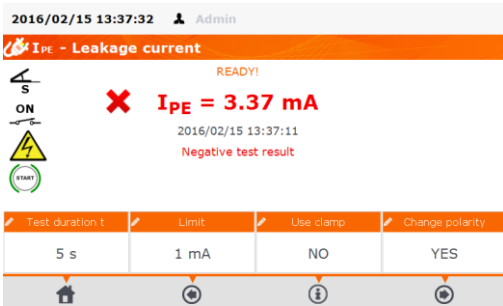

Negative test result: $I_{PE} > LIMIT$

Notes:



During the measurement in the test socket the mains voltage is present.

During the measurement of a faulty appliance, RCD switch may be triggered off.

- PE leakage current is measured directly on this line enabling the user to get precise measurement results even when the device consumes a current of 10A or 16A. Note that if the current leakage is not caused by PE line but by other earthed elements (e.g. water pipe) – it cannot be measured in this measurement function. In that case it is advised that the differential leakage current method of testing should be used instead, it is advised to measure differential leakage current.
- Ensure that the location of the tested device is isolated.
- Tested appliance must be turned on.
- When **Change polarity** is set on **YES**, after the set time duration is over the tester automatically changes the polarity of the test mains socket and resumes the test. As a test result it displays the value of the higher leakage current.
- Blown 15A fuse indication can equally mean that the overcurrent protection system within the electrical network, by which the tester is powered, was activated.

4.7 Measurement of differential leakage current

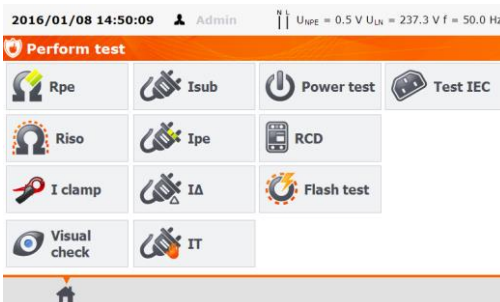
①



Press **IA**.

Before starting the measurement, similarly to the measurement of PE resistance test (see 4.2 of this manual), following parameters must be set: **test duration, limit** and:

- 2 In **Use clamp** select **YES**, if clamp is to be used for the measurement, or **NO** if the test is to be performed in test socket of the tester.
In **Change polarity** select **YES**, if the measurement is to be repeated for reverse polarity or **NO**, if the measurement is performed for only one polarity.

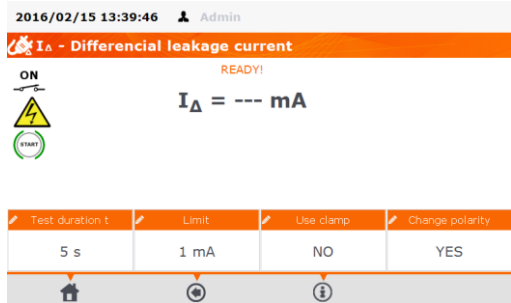

Measurement without clamp:

- 3 Connect the mains plug of the tested appliance into the test socket of the tester.

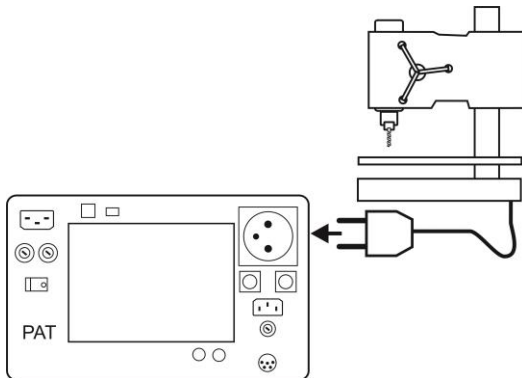

Measurement with clamp:

- 3 Attach clamp around L and N conductors.

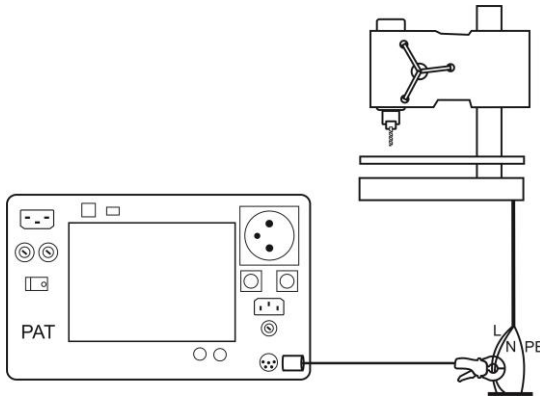

4



Press **START**.

Upon completing the measurement read the result. The test can be finished before the defined test time duration by pressing **STOP**.

2016/02/15 13:41:11 Admin

I_Δ - Differential leakage current

ON READY!



I_Δ = 0.21 mA

2016/02/15 13:40:57
Positive test result

Positive test result: $I_{\Delta} < \text{LIMIT}$

Test duration t	Limit	Use clamp	Change polarity
5 s	1 mA	NO	YES

2016/02/15 13:43:24 Admin

I_Δ - Differential leakage current

ON READY!



I_Δ = 2.37 mA

2016/02/15 13:43:13
Negative test result

Negative test result: $I_{\Delta} > \text{LIMIT}$

Test duration t	Limit	Use clamp	Change polarity
5 s	1 mA	NO	YES

Notes:



During the measurement in the test socket the mains voltage is present.

During the measurement of a faulty appliance, RCD switch may be triggered off.

- Differential leakage current is measured as a difference between L current and N current. This measurement takes into account not only PE leakage current, but also leakage currents caused by other earthed elements - e.g. water pipe. The disadvantage of this measurement is the presence of common current (supplied to the device through L line and returning via N line), which makes the measurement difficult. If this current is high, the measurement will be less accurate (as described in the technical data) than the measurement of PE leakage current.
- When **Change polarity** is set on **YES**, after the set time duration is over the tester automatically changes the polarity of the test mains socket and resumes the test. As a test result it displays the value of the higher leakage current.
- The result of measurement may be affected by the presence of external fields and by the current used by the device.
- Blown 15A fuse indication can equally mean that the overcurrent protection system within the electrical network, by which the tester is powered, was activated.

4.8 Measurement of touch leakage current

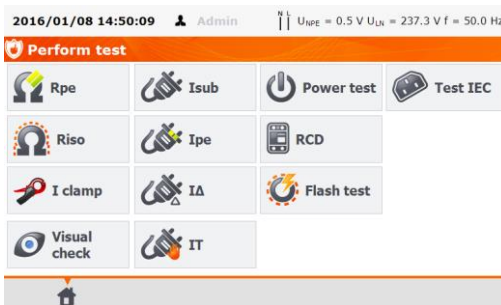
①



Press IT.

Before starting the measurement, similarly to the measurement of PE continuity test (see 4.2 of this manual), following parameters must be set: **test duration, limit** and:

2

in **Change polarity** select **YES**, if the measurement is to be repeated for reverse polarity or **NO**, if the measurement is performed for only one polarity.

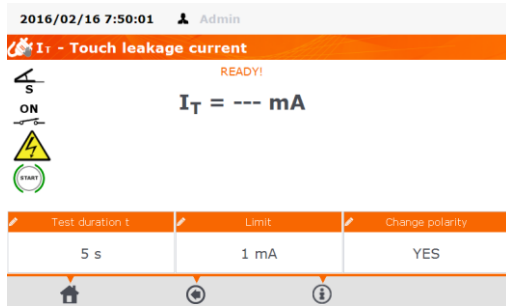

3

Connect the mains plug of the tested device into the test socket of the tester. Use the probe connected to T2 terminal socket and touch the accessible parts of the tested device. (For Class I devices - touch accessible parts disconnected from PE).

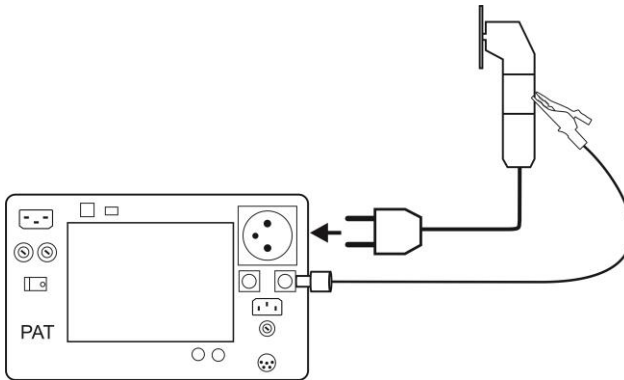

4



Press **START**.

Upon completing the measurement read the result. The test can be finished before the defined test time duration by pressing **STOP**.

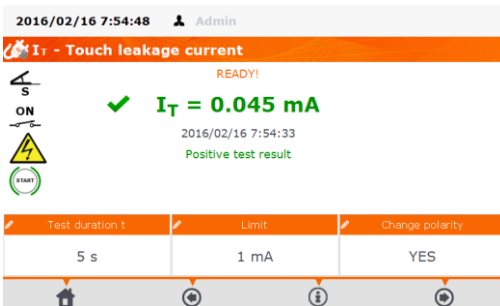

Positive test result: $I_T < \text{LIMIT}$

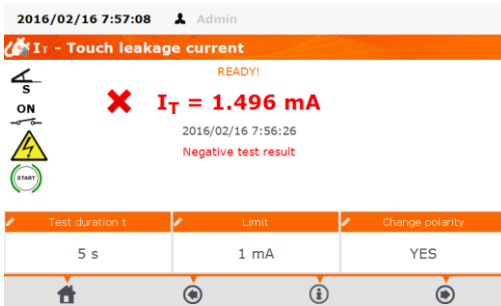

Negative test result: $I_T > \text{LIMIT}$

Notes:

⚠
During the measurement in the test socket the mains voltage is present.

⚠
During the measurement of a faulty appliance, RCD switch may be triggered off.

- When **Change polarity** is set on **YES**, after the set time duration is over the tester automatically changes the polarity of the test mains socket and resumes the test. As a test result it displays the value of the higher leakage current.
- When tested device is powered from other socket, the measurement should be performed at both mains plug positions and as the result the higher current value should be accepted. When the device is powered from the PAT's sockets in auto tests, L and N terminals are swapped by the tester.
- The bandwidth of test current results from the measuring system with adjusted touch current which simulates human perception and reaction, in accordance with EN 60990: 2002.

4.9 Measurement of P and S Power, PF Power Factor, current consumption and voltage

①

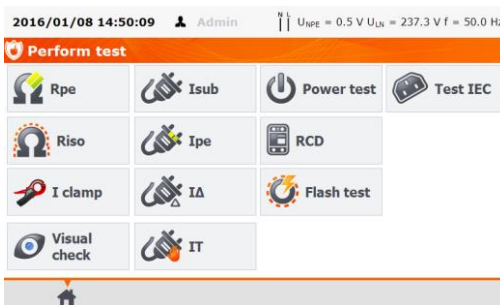

Press **Power test**.

Before starting the measurement, similarly to the measurement of PE continuity test (see 4.2 of this manual), following parameters must be set: **test duration**, and:

2

In Use clamp select **YES**, if clamp is to be used for the measurement, or **NO** if the test is to be performed in test socket of the tester.

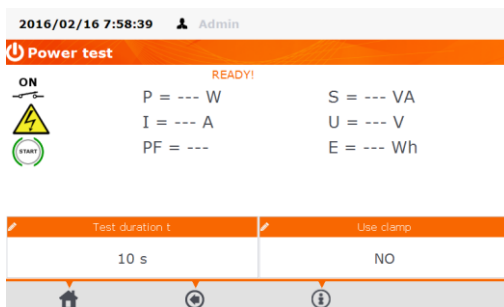

Measurement without clamp:

3

Connect the mains plug of the tested appliance into the test socket of the tester.

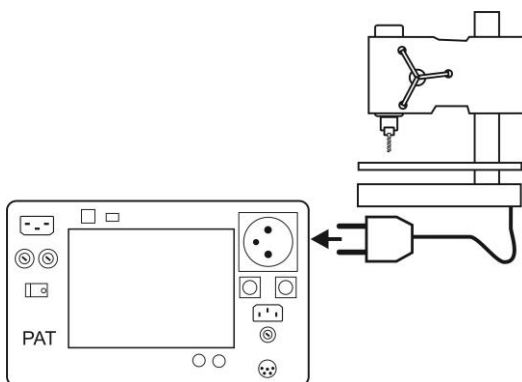

Measurement with clamp:

3

Attach clamp around L conductor. To L and N conductors of IEC lead connect corresponding L and N conductor of the power cord of the tested device.

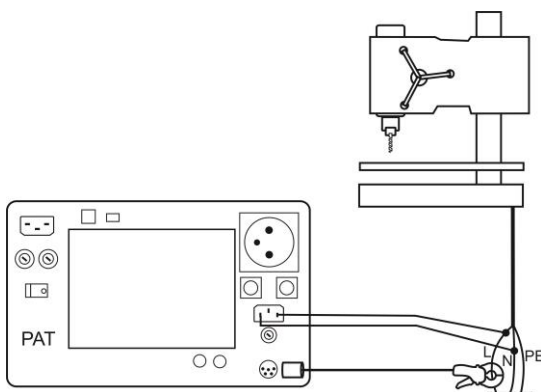

4



Press **START**.

The test can be finished before the defined test time duration by pressing **STOP**.

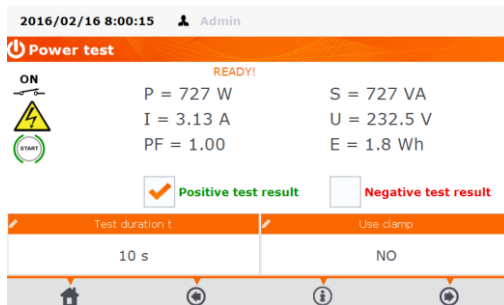

Upon completing the test read the results and compare them with the technical data of the tested device. The assessment of the correctness of the test results can be performed by selecting the proper field in '**Positive test result**' or '**Negative test result**'. When saving test results in the memory, this assessment will also be saved along with the results.

Notes:



During the measurement in the test socket the mains voltage is present.

- Blown 15A fuse indication can equally mean that the overcurrent protection system within the electrical network, by which the tester is powered, was activated.

4.10 Current measurement with clamp (only PAT-815 and PAT-820)

1

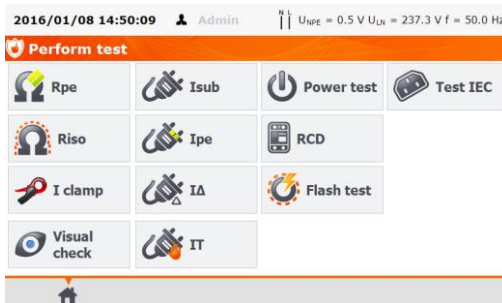

Press **I clamp**.

Before starting the measurement, similarly to the measurement of PE continuity test (see 4.2 of this manual), following parameters must be set: **test duration**, **limit** and:

2

in **Current range** select low range (**0mA ÷ 100mA**) or High (**0.1A ÷ 24.9A**).

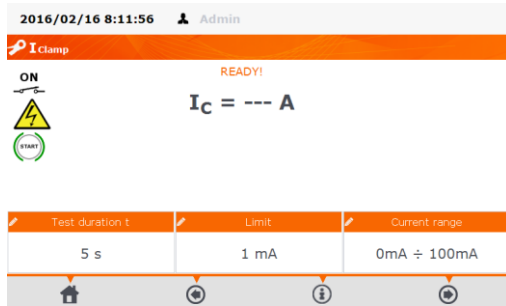

3

Attach clamp around measured conductor.

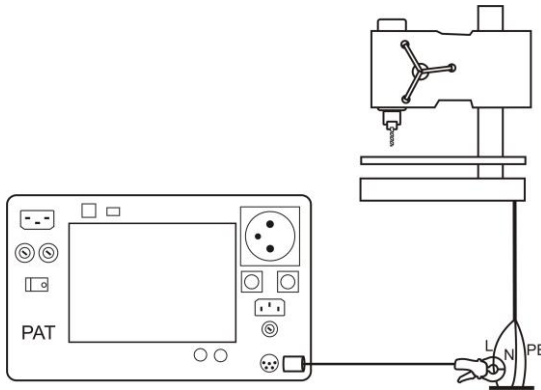

4



Press **START**.

The test can be finished before the defined test time duration by pressing **STOP**.

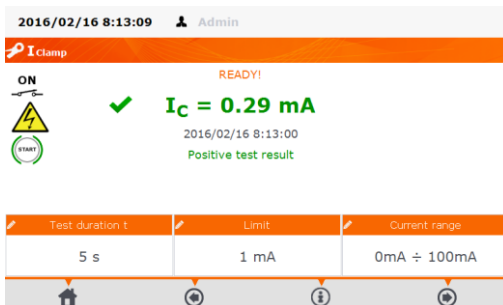

Positive test result: $I_L < \text{LIMIT}$



Negative test result: $I_L > \text{LIMIT}$

Note:

During the measurement in the test socket the mains voltage is present.

4.11 IEC cable test

IEC lead test includes wires continuity checking, short circuits between the wires and correctness of L-L and N-N connection and PE resistance and insulation resistance measurement.

①

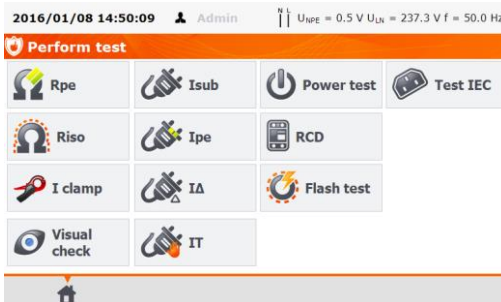

Press **Test IEC**.

②

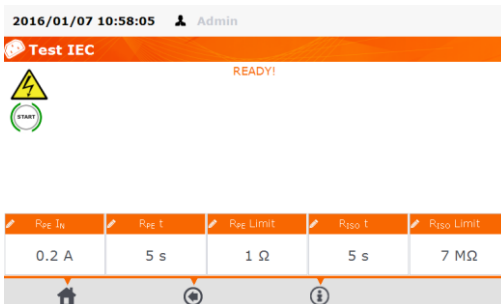

Before the measurement, in the same manner as in previous measurements, the following parameters must be set: current, measurement time and limit R_{PE} as well as measurement time and limit R_{ISO} .

③

Connect the mains plug of the cord into the test socket and the other end of the cord into the IEC socket on the tester.

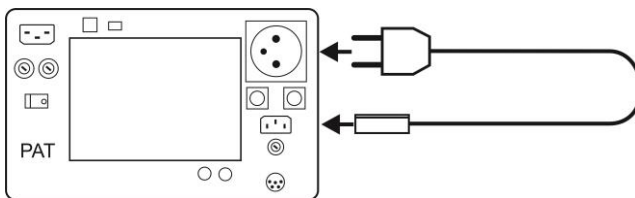



4



Press **START**.
 The test can be finished before the defined test time duration by pressing **STOP**.
 Upon completing the test read the result.

2016/01/07 11:00:26 Admin

Test IEC READY! Polarity: Correct

  **Positive test result** RPE = 118 mΩ

RISO > 599.9 MΩ



2016/01/07 11:00:13

R _{pe} I _n	R _{pe} t	R _{pe} Limit	R _{iso} t	R _{iso} Limit
0.2 A	5 s	1 Ω	5 s	7 MΩ

Positive test result.

2016/01/07 11:01:36 Admin

Test IEC READY! Polarity: L wire break

  **Negative test result** RPE = ---

RISO = ---

2016/01/07 11:01:18

R _{pe} I _n	R _{pe} t	R _{pe} Limit	R _{iso} t	R _{iso} Limit
0.2 A	5 s	1 Ω	5 s	7 MΩ

Negative test result.

Additional information displayed by the tester

- Information about irregularities in the lead are displayed in the test results field.
- The following message appears when testing a cable with disconnected RCD. When the connection is not established during 4 s, the meter assumes that there is a break in the circuit.

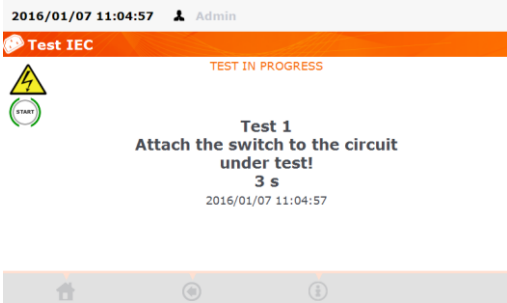

4.12 Measurement of fixed RCD parameters

- 1 Connect the mains plug of the tester into the tested socket.

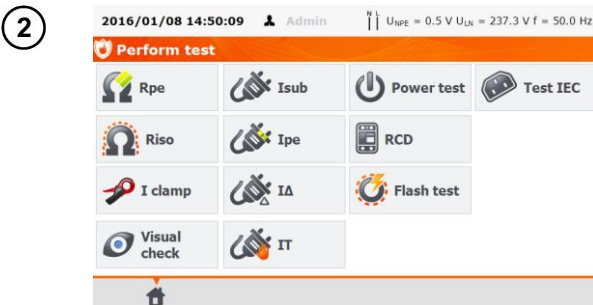
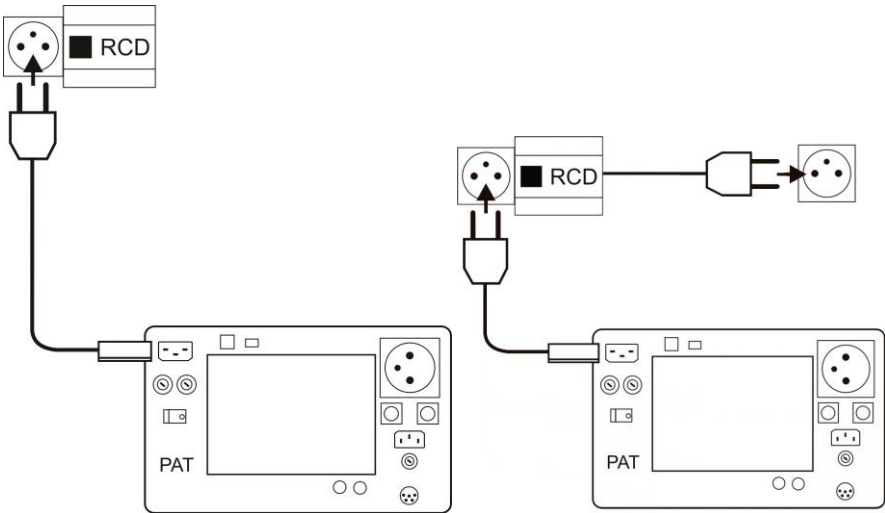

Press RCD.

Before starting the measurement, following parameters must be set:

3

... $I_{\Delta n}$ current- select one of the available values,

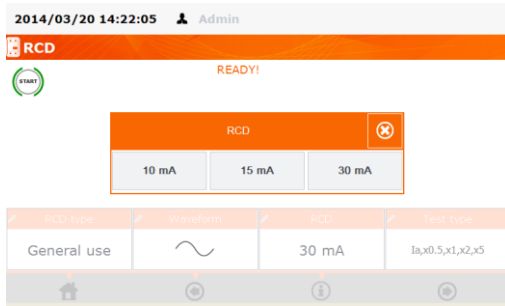

4

RCD type - general use or fast trip, by pressing on **RCD type** field, waveform (shape of the current) - initial phase positive, negative or both, by pressing **Waveform**

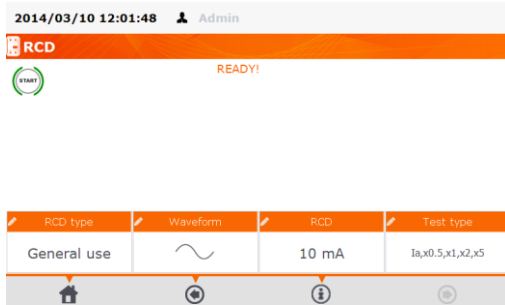

4

Test type by pressing **Test type**, and selecting one of available options : I_a , t_a ($x0.5I_{\Delta n}$; $x1I_{\Delta n}$; $x2I_{\Delta n}$; $x5I_{\Delta n}$)

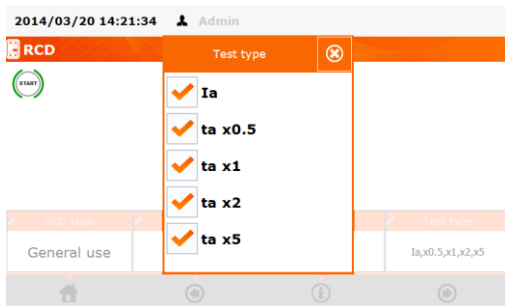

5



Press **START**. Switch on RCD whenever it trips. Upon completing the test read the result.

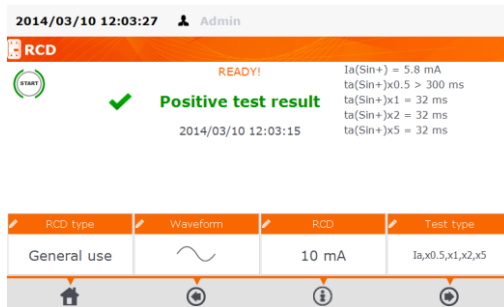

Appliances with RCD – AUTO mode tests, see section 4.13.

Note:

- Due to the built-in rechargeable battery, the tester's power supply is sustained for 8 mins after RCD trips. RCD must to be immediately switched on after RCD trips.

4.13 AUTO mode tests

In this mode, readiness for the next measurement occurs without the need of returning to the menu. AUTO test mode tests can be performed in two ways:

- fully automatic- every subsequent test will be executed without the need for the user's approval (provided that the previous test result is positive).
- semi automatic - upon completing each test the tester will stop the sequence and the readiness for the next test will be indicated on screen. Commencing subsequent test will require pressing **START** button.

4.13.1 Configuring AUTO mode tests

- 1 Go to Main Menu and press **Configuration of tester**.

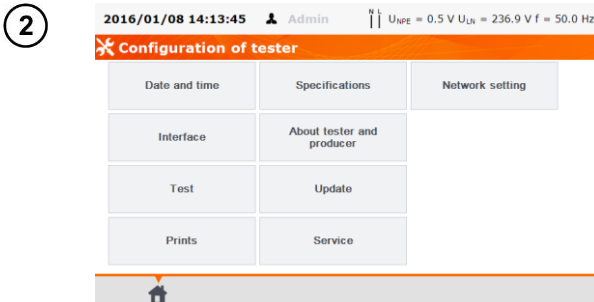

Press Test

3

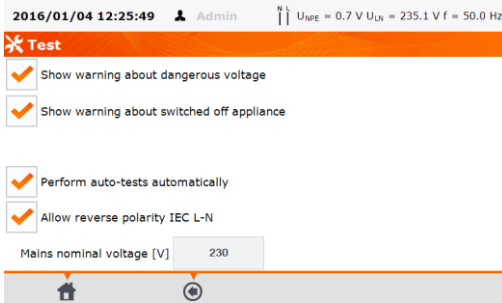

If each test is meant to be executed one after another automatically **Perform auto-tests automatically** option must be selected. Otherwise each test will be executed separately by pressing **START** button.

Note:

- When the **Multibox** function is enabled, the user has to repeat the measurements of the same parameter by pressing the **START** button. Press the  button to go to measurements of the next parameter (also when the **Perform auto-tests automatically** option is active).

4.13.2 AUTO mode tests



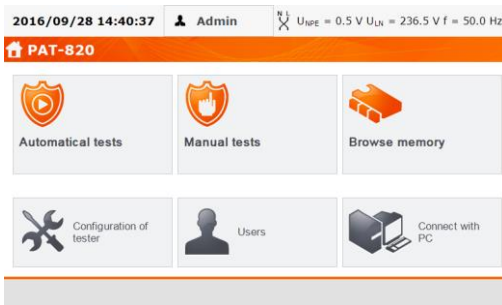

1

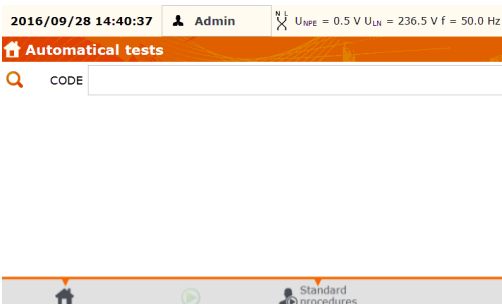

Press **Automatical test**.

2



The user has the ability to program your own list using the computer program "Sonel Analysis". Toggle between lists with buttons  **User's procedures** and  **Standard procedures**. The list can be scrolled with  and .

3

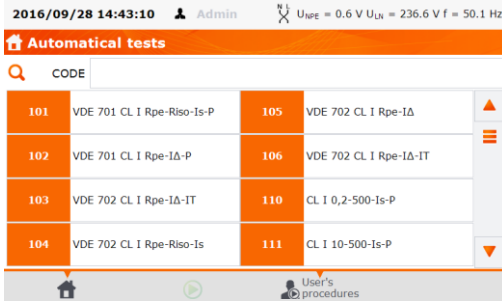

Select the test number from the list or scan the code from the proper barcode (or 2D code) with the barcode reader (PAT automatically detects connected barcode reader). If the test method was previously assigned to the selected appliance, it will now be highlighted.

Note:

- Different test methods (sequences) are linked to each number (code).



4

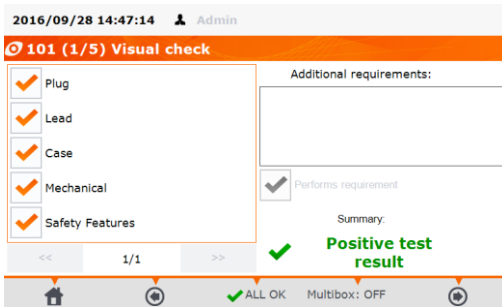

Select the code (manually or scan the code printed on the appliance's label) by pressing  (**START**) buton on screen.

5



For this example: after initial visual check, select proper fields on the left side of the screen (confirming or not the correctness of the statement). Press  **ALL OK** to select all fields. By pressing **Additional requirements** text note for visual check can be added. Proceed by pressing  (**Next**).

Multibox: Enabling this function (Multibox: ON) allows the user to perform multiple measurements of the parameter (except power), whereas each measurement is treated as a separate (not just repeated) and all of them may be saved to the memory. To perform next measurement of the same parameter, use **+** button and press **START**. To perform next parameter, use  button and press **START**. The Multibox function is disabled by default. Use "Sonel Analysis" software to permanently enable a user procedure.

Measuring circuit for each test is the same as for its corresponding manual measurement.

Multibox: OFF

6

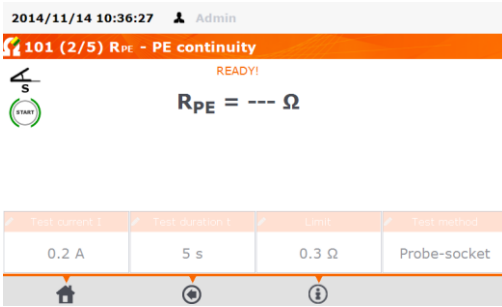

Press **START** to commence the test sequence.

7

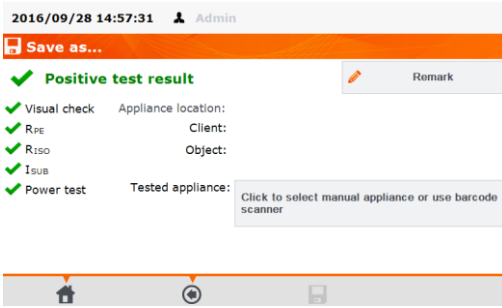

Upon completion of the measurement procedure a summary screen is displayed. The results can be saved into memory (see section 5).

Multibox: ON

6

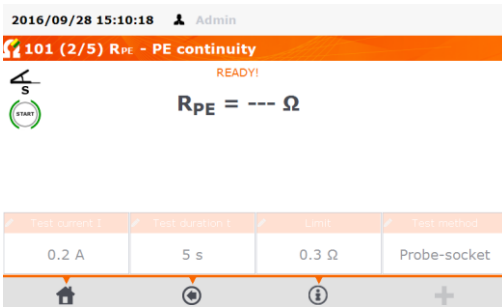

Press **START** button on the device to start the first measurement.

7

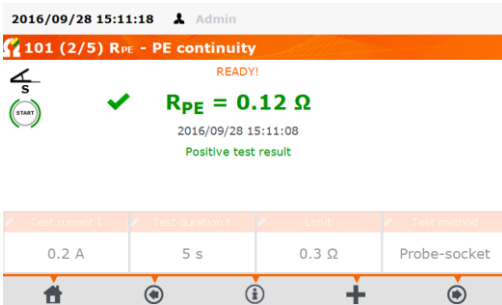

Click **+** button to go to the next R_{PE} measurement or use **▶** button to move to the measurement of the next parameter.

After pressing button **+**:

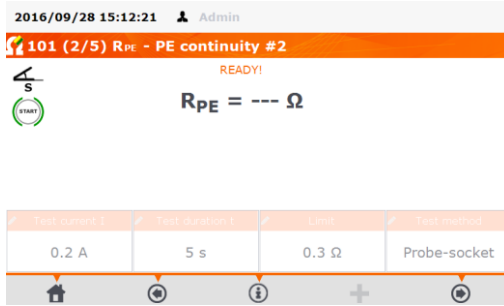

8

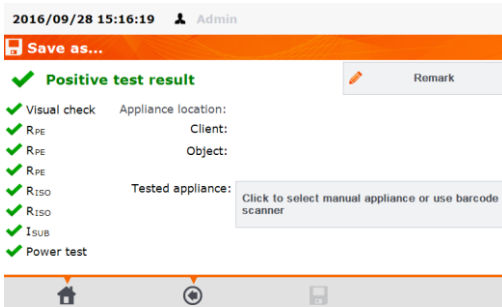

The summary screen will display as many symbols of the parameter as the number of performed measurements – in this example: three R_{PE} and two R_{ISO}.

Notes:

- The test can be finished before the defined test time duration by pressing **STOP** button on the front panel of the tester.
- When the result of a single test of the sequence is negative, the tester stops the sequence and does not proceed with the remaining tests. The failed test can be repeated (e.g. to verify whether the negative result was due to a connection error) by pressing hardware **START** button. To complete the test sequence and save the negative result into memory, press **Next** to proceed with the next test in the sequence or complete the procedure.

4.13.3 Measurements (of items like IEC leads, extension leads) with RCD in AUTO mode

1

Connect mains plug of appliance with RCD into test socket of the tester, and the appliance's socket connect with adapter shuko/IEC (see 10.3 Optional accessories) into IEC socket of the tester.

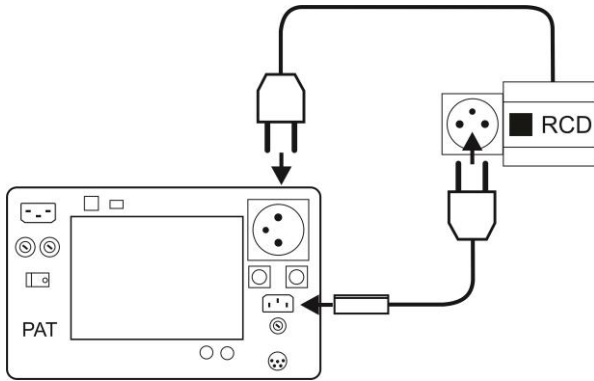

2

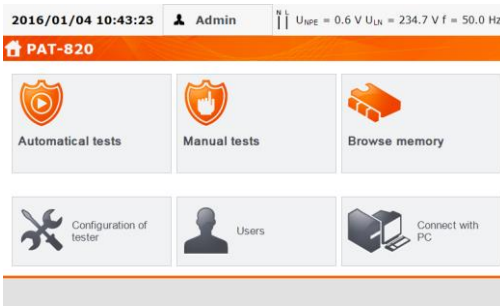

Press **Automatical test**.

3

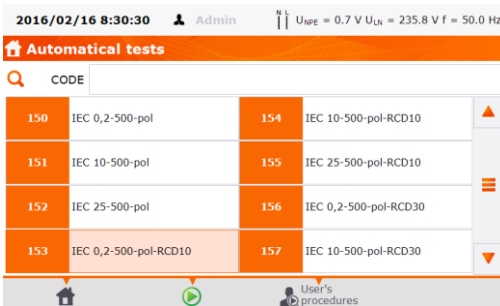

Select correct code.

For code 153:

4

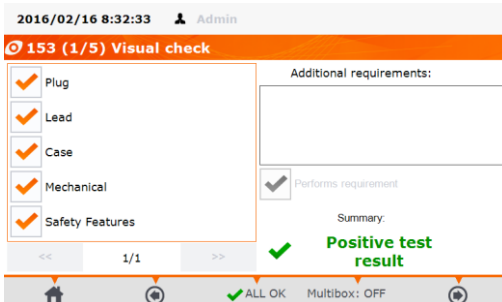

Perform visual inspection of the appliance and mark proper checkboxes if the inspection result was positive. If every-

thing is fine, **ALL OK** can be pressed to mark them all at once.

- 5 Press , to proceed to connections test R_{PE} test.

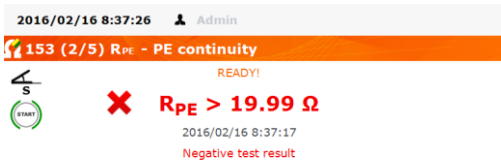
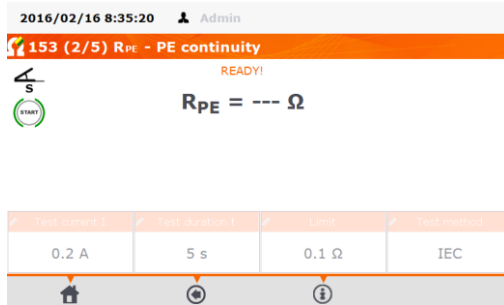

Negative test result

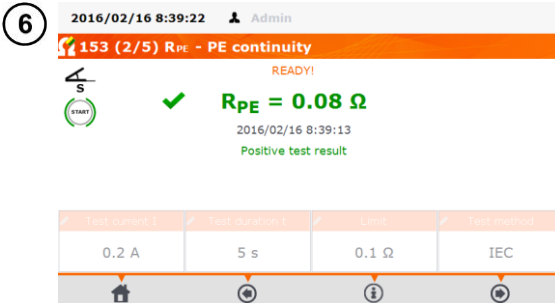

If R_{PE} test result is positive, press , tester goes to R_{ISO} measurement. Start the R_{ISO} measurement.

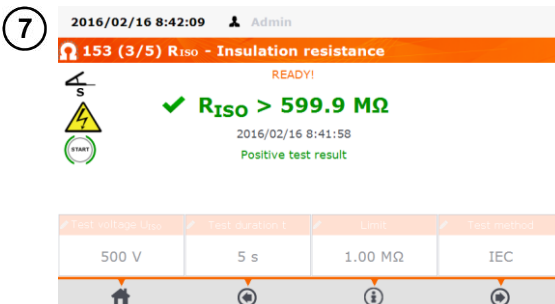

In case, the measurement result R_{ISO} is correct press , tester goes to connections test. Start the connections test.



Negative test result

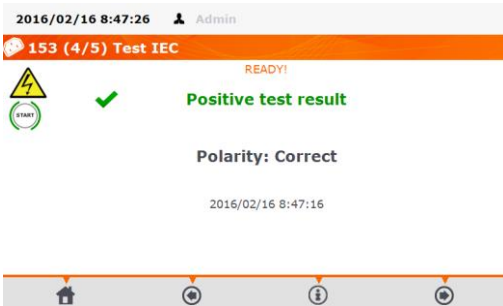

Positive test result

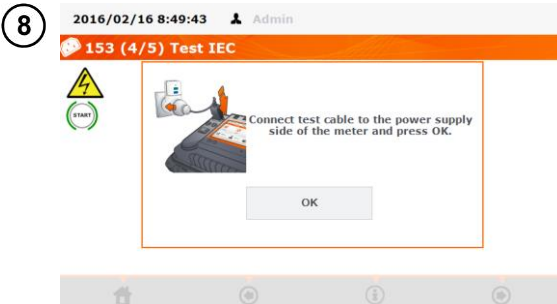

In case, the connections test result is correct follow the on-screen command. Disconnect the device from the RCD and connect it to a wall socket (mains) and then connect the power cord of the tester to the socket of the device.

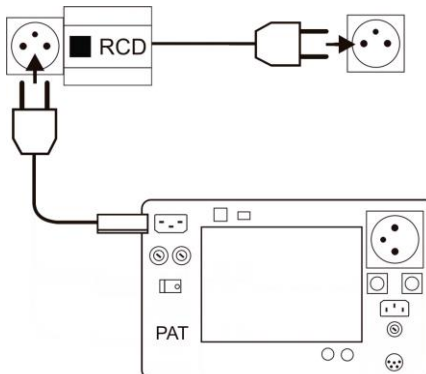

9

2016/02/16 8:57:43 Admin

153 (5/5) RCD

READY!



Start RCD test. Put RCD on after each tripping.



RCD type	Waveform	RCD	Test type
General use		10 mA	Ia,x1

Home | Stop | Info

2016/02/16 9:07:04 Admin

153 (5/5) RCD

READY!

  **Positive test result**

Ia(Sin+) = 6.3 mA
Ia(Sin-) = 6.3 mA
ta(Sin+)x1 = 148 ms
ta(Sin-)x1 = 148 ms

2016/02/16 9:06:45

RCD type	Waveform	RCD	Test type
General use		10 mA	Ia,x1

Home | Stop | Info | Start

Note:

- With the built-in battery, PAT's power supply is sustained for up to 8 mins, after RCD trips, and cuts off mains power supply. It is advised to switch on RCD immediately after it trips.

5 Memory of measurement results data

The testers' memory of the measurement results data has a tree structure. The User can save data for any number of Clients. Any number of Sites can be assigned to each Client. Up to 4 levels of tree branches can be assigned to each Site, with any number of Locations/Areas for each level. Any number of appliances can be created for each Site and Location/Area. The whole memory structure is limited only by the size of the built-in memory (4GB as standard).

5.1 Storing the measurement results in the memory

1

2016/02/16 9:09:45 Admin

R150 - Insulation resistance

READY!

✓ **R₁₅₀ > 599.9 MΩ**

2016/02/16 9:09:32
Positive test result

Test voltage U _{iso}	Test duration t	Limit	Test method
500 V	10 s	10.00 MΩ	Probe-socket

For a single test, after the test is done, press (Next).

2

2016/02/16 9:11:34 Admin

Save as...

✓ **Positive test result** Remark

✓ R₁₅₀ Appliance location:
Client: Not selected
Object: ---

Tested appliance:
Click to select manual appliance or use barcode scanner

For both Manual and Auto tests, press '**Click to select manual appliance ...**' to select the appliance for which the test results are to be stored, or scan the code from the label of the tested appliance.

3

2016/02/16 9:12:40 Admin U_{ME} = 0.7 V U_{LN} = 234.9 V f = 50.0 Hz



\004\Building 1\Room 1

Objects	Appliance
123/p/2003	monitor

Managing the printer is off:
Select the appliance from the appliance data base (or add a new one), highlight your selection and press (Save).

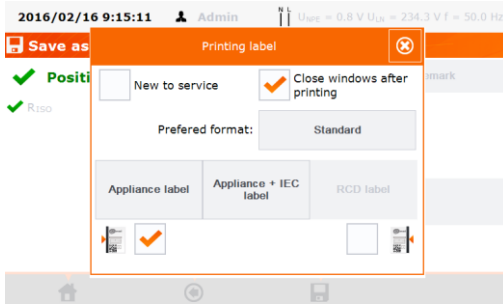
4



Managing the printer is on: Select the appliance in the database (or add a new one) and after selecting of the choice, press , the appliance will be selected. Select proper checkbox if the device is being tested for the first time, and another checkbox for choosing how to mark label with the side stripe (for retest period). Click the button with selected type of label - the label is printed and the result is recorded. Closing the window using  will result in saving the result without printing the label.

Note:

- When the appliance ID is scanned prior to the test in AUTO mode, the appliance will be selected automatically.

5.2 Browsing memory data

1

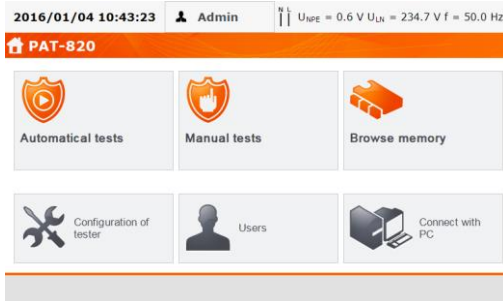

Press **Browse memory**.

2

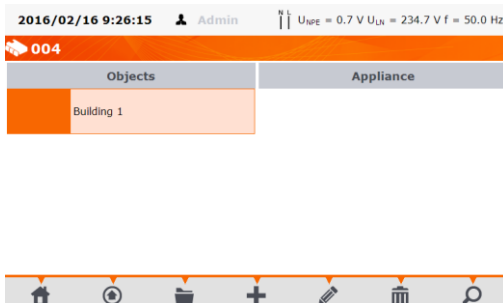

Double click on (or single press and then press  **Open**) each element (Client - Object... - Appliance) until you select desired appliance.

3

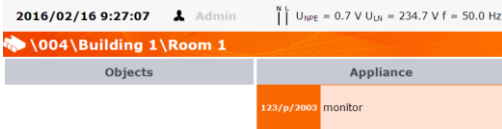

Double click on (or single press and then press  **Open**) the selected appliance to open its test history.



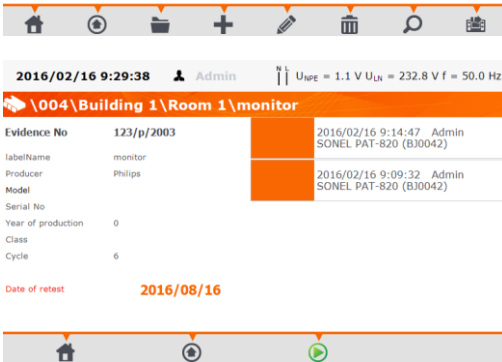

4

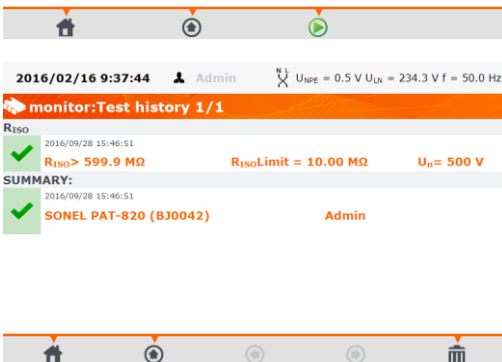

The appliance data is on the left, and the list of the tests performed is displayed on the right. Click on the selected test for details.

5



Test results screen (or several screens for AUTO mode). Using  and  scroll through next/previous results pages. Press  to go back to the list of tests results. Use button  (**Delete**) to delete the test result.

5.3 'Search' option in the memory

A search option has been added in to the memory browser, to make the wanted object or appliance easier to find. To activate this function:

1

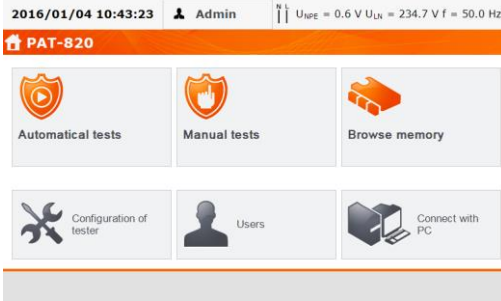

Press **Browse memory**.

2

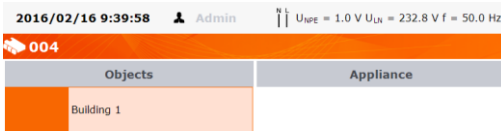

Press  (**Search**) at any memory search window.

3



Select between **Objects** and **Appliance** and then fill out the search boxes to identify the appliance. Then press **Search**.

4

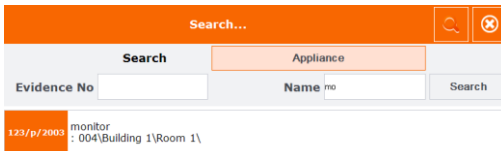

If there is a high amount of results, the search panel is hidden -it may be displayed again by clicking button .

Note:

- The size of letters in this option is ignored.

5.4 Moving Appliance into another Object

1

2016/02/16 9:47:15 Admin U_{HP}E = 1.0 V U_{LN} = 233.4 V f = 50.0 Hz

\004\Building 1\Room 1

Objects	Appliance
	123/p/2003 monitor

Select the appliance to be moved and press .



2

2016/02/16 9:48:57 Admin U_{HP}E = 1.0 V U_{LN} = 233.5 V f = 50.0 Hz

\004\Building 1\Room 1

New location	Appliance to move
	Evidence No: 123/p/2003 Name: monitor Serial No: Current location: 004\Building 1\Room 1

Move appliance to:
004\Building 1\Room 1

Press  (Open).
Press  to cancel the moving procedure.

3

2016/02/16 9:49:50 Admin U_{HP}E = 1.1 V U_{LN} = 232.5 V f = 50.0 Hz

004\Building 1

New location	Appliance to move
Room 1	Evidence No: 123/p/2003 Name: monitor Serial No: Current location: 004\Building 1\Room 1
Room 2	

Move appliance to:
004\Building 1

Find new location and open it with .

4

2016/02/16 9:50:55 Admin U_{HP}E = 1.0 V U_{LN} = 233.1 V f = 50.0 Hz

\004\Building 1\Room 2

New location	Appliance to move
	Evidence No: 123/p/2003 Name: monitor Serial No: Current location: 004\Building 1\Room 1

Move appliance to:
004\Building 1\Room 2

Press .

5.5 Copying Client's data from memory into USB flash drive (back and forth)

1 Insert USB flash drive into appropriate USB slot of the tester.

2016/02/16 9:54:03 Admin U_{HP} = 1.0 V U_{LN} = 232.1 V f = 50.0 Hz

Tester memory

Clients:		Information about client:
004	SONEL S.A. client_4.client	Client ID: 004 Name: SONEL S.A. Address: Main str. 10 53-86 Town City Phone: 355576876 E-mail: info@sonel.uk Contact person:John Smith

Home, Folder, Search, Add, Edit, Delete, USB



To copy data into USB flash drive, select Client and press .

3 2016/02/16 9:56:09 Admin U_{HP} = 1.0 V U_{LN} = 232.7 V f = 50.0 Hz

USB memory

Clients:		Information about client:
004	SONEL S.A. client_4.client	Clients were not found. Click Add (+) in order to add new client.

Home, Folder, Search, Add, Edit, Delete, USB

To copy data from USB flash drive into the tester's memory, browse the memory, select a Client and press . Flash drive's content will be displayed. Press  to go back to displaying stored data in the tester's memory.

4 2016/02/16 9:57:33 Admin U_{HP} = 1.0 V U_{LN} = 232.5 V f = 50.0 Hz

USB memory

Clients:		Information about client:
004	SONEL S.A. client_4.client	Client ID: 004 Name: SONEL S.A. Address: Main str. 10 53-86 Town City Phone: 355576876 E-mail: info@sonel.uk Contact person:John Smith

Home, Folder, Search, Add, Edit, Delete, USB

Select a Client and press .

5.6 Deleting memory data

1

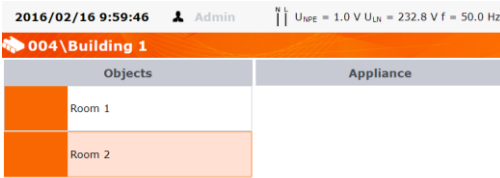

To delete client, object, appliance or test, select the item and press  (**Delete**).

2

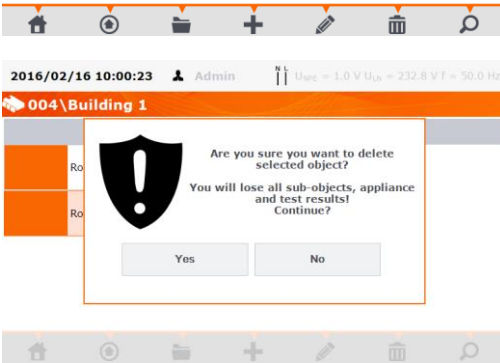



Press **Yes**, to confirm deletion, or **No**, to cancel.

6 Label printing

To print a label, the printing label option must be selected under Tester Configuration settings on home screen of the tester, and, if needed, the option for auto printing after test results are saved, can be enabled (see section 3.3.5). Printer must be connected to one of the Host type USB sockets to allow printing. Printing is available in the cases:

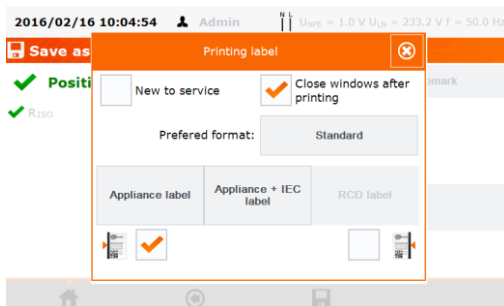
- when a single test is completed, and its result is being displayed on screen, after pressing  (**Save**) the tester will automatically ask to print a label:



When selecting **Perform auto-tests automatically** in the menu (see sec. 3.3.5), the label is printed immediately after pressing  (**Save**).

- after completing the AUTO test sequence, when the results are displayed the tester will automatically ask to print a label:

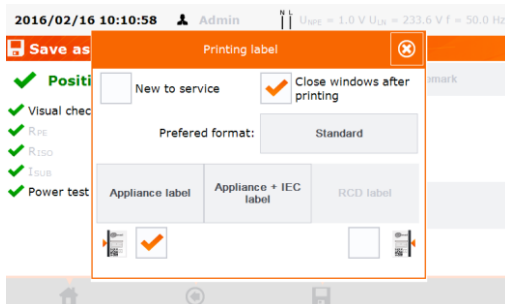

- when browsing memory, when a selected cell contains test results, press  (Print) icon.

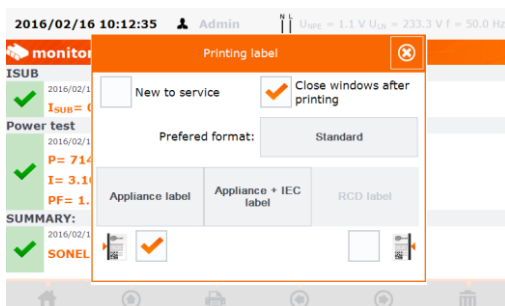

When **Printing Label** window shows up, select **New to service** if the device is being tested for the first time, and if using reference strikes also tick the appropriate box, corresponding to the selected retest period (see 3.3.5).

Label types. There are four types of label:

- **Appliance label**: Basic printout for appliances with fixed power cord,
- **Appliance/IEC label**: Printout for appliances with detachable power cord that were tested with their power cord. Two labels will be printed. One for the appliance, and the second one for the IEC cord and two tests will be saved to the tester memory.
- **Small RCD label**: test results printout for basic RCD's parameters (tripping current I_A , disconnection time t_A for $1xI_{\Delta n}$),
- **Big RCD label**: general RCD test result printout, along with individual test results presented as 2D code.

Retest period can be put on label as a code. Exemplary retest codes for a device using the tester's default settings is as follows:

- 3 months retest period: stripes are printed along the left side of the label
- 6 months retest period: stripes are printed along the right side of the label
- 12 months retest period: stripes are printed along both sides of the label
- other retest period: no stripes printed.

Settings can be changed through 'Sonel Analysis' program, after connecting the tester to PC.

7 Cleaning and maintenance

NOTE!

Apply solely the maintenance methods specified by the manufacturer in this manual.

The casing of the tester may be cleaned with a soft, damp cloth using all-purpose detergents. Do not use any solvents or cleaning agents which might scratch the casing (powders, pastes, etc.). Touch screen may be cleaned with all available cleaners dedicated for LCD screens.

The electronic system of the tester does not require maintenance.

8 Storage

In the case of storage of the device, the following recommendations must be observed:

- Disconnect all the test leads from the tester,
- Clean the tester and all its accessories thoroughly.

9 Dismantling and disposal

Used electrical and electronic equipment should be collected selectively, i.e. it must not be placed with other kinds of waste.

Used electronic equipment should be sent to a collection point in accordance with the Used Electrical and Electronic Equipment Act.

Before the equipment is sent to a collection point, do not dismantle any elements.

Observe the local regulations concerning disposal of packages.

10 Specifications

- ⇒ Abbreviation 'm.v.' used in the specification of measurement uncertainty means a standard measured value.
- ⇒ Ranges and uncertainties are additionally provided according to DIN VDE 404-1.

Measurement of network voltage

Display range	Resolution	Measurement uncertainty (basic)
195,0 V...265,0 V	0,1 V	±(2% m.v. + 2 digits)

- measurement of the mains voltage between L and N of the power supply

Measurement of network frequency

Display range	Resolution	Measurement uncertainty (basic)
45,0 Hz...55,0 Hz	0,1 Hz	±(2% m.v. + 2 digits)

- measurement of the mains voltage frequency of the power supply

Measurement of PE network (mains) voltage

Display range	Resolution	Measurement uncertainty (basic)*
0,0 V...59,9 V	0,1 V	±(2% m.v. + 2 digits)

- measurement of the mains voltage between PE and N of the power supply

* for $U < 5V$ accuracy is not specified

Measurement resistance of protective conductor I=200mA (only Protection Class I)

Display range	Resolution	Measurement uncertainty (basic)
0,00 Ω ...0,99 Ω	0,01 Ω	±(4% m.v. + 2 digits)
1,00 k Ω ...19,99 Ω		±(4% m.v. + 3 digits)

Influencing factor	Designation	Additional uncertainty
Position	E_1	0%
Supply voltage	E_2	0%
Temperature	E_3	0,1%/°C for $R \geq 0,5 \Omega$ 0%/°C for $R < 0,5 \Omega$

- unloaded output voltage: 4 V... 12 V AC
- Test current: $\geq 200mA$ for $R = 0.2 \Omega \dots 1.99 \Omega$
- adjustable upper limit in the range of: 10 m Ω ... 1.99 Ω with resolution 0.01 Ω
- adjustable measuring time: 1 s...60 s with a resolution of 1 s and option **Continuous test**

Measurement resistance of protective conductor I=10A (only Protection Class I)

Display range	Resolution	Measurement uncertainty (basic)
0 mΩ...999 mΩ	1 mΩ	±(3% m.v. + 4 digits)
1,00 Ω...1,99 Ω	0,01 Ω	

Influencing factor	Designation	Additional uncertainty
Position	E ₁	0%
Supply voltage	E ₂	0%
Temperature	E ₃	0,1%/°C

- unloaded output voltage: <12 V AC
- test current: ≥ 10 A for R ≤ 0,5 Ω
- adjustable upper limit in the range of: 10 mΩ ...1,99 Ω with resolution 0.01 Ω
- adjustable measuring time in the range of: 1 s...60 s with resolution of 1 s

Measurement resistance of protective conductor I=25A (only Protection Class I)

Display range	Resolution	Measurement uncertainty (basic)
0 mΩ...999 mΩ	1 mΩ	±(3% m.v. + 4 digits)
1,00 Ω...1,99 Ω	0,01 Ω	

Influencing factor	Designation	Additional uncertainty
Position	E ₁	0%
Supply voltage	E ₂	0%
Temperature	E ₃	0,1%/°C

- unloaded output voltage: <12 V AC
- test current: ≥ 25 A for R ≤ 0,2 Ω
- adjustable upper limit in the range of: 10 mΩ ...1,99 Ω with resolution 0.01 Ω
- adjustable measuring time in the range of: 1 s...60 s with resolution of 1 s

Measurement of insulation resistance using test voltage of 100V (only PAT-815/820)

Test range according to IEC 61557-2 for UN = 100V: 100kΩ...99.9MΩ

Display range	Resolution	Measurement uncertainty (basic)
0 kΩ...1999 kΩ	1 kΩ	± (5% m.v. + 8 digits)
2,00 MΩ...19,99 MΩ	0,01 MΩ	
20,0 MΩ...99,9 MΩ	0,1 MΩ	

Influencing factor	Designation	Additional uncertainty
Position	E ₁	0%
Supply voltage	E ₂	0%
Temperature	E ₃	0,1%/°C
Capacity	E ₇	0% for R ≤ 20 MΩ Unspecified for R > 20 MΩ

- Accuracy of generated voltage (Robc [W] ³ 1000*UN [V]): -0 +30% from the set value
- nominal current: min 1 mA...1.4 mA
- adjustable lower limit within the range of 0.1 MΩ ...9.9 MΩ with resolution of 0,1 MΩ
- adjustable measuring time: 3 s...3 min with a resolution of 1 s and option **Continuous test**
- detection of a dangerous voltage before commencing a measurement
- discharging the object tested

Note: For R <50kΩ, the uncertainty is not specified.

Measurement of insulation resistance using test voltage of 250V (only PAT-815/820)

Test range according to IEC 61557-2 for $U_N = 250\text{ V}$: 250 k Ω ...199.9 M Ω

Display range	Resolution	Measurement uncertainty (basic)
0 k Ω ...1999 k Ω	1 k Ω	\pm (5% m.v. + 8 digits)
2,00 M Ω ...19,99 M Ω	0,01 M Ω	
20,0 M Ω ...199,9 M Ω	0,1 M Ω	

Influencing factor	Designation	Additional uncertainty
Position	E ₁	0%
Supply voltage	E ₂	0%
Temperature	E ₃	0,1%/°C
Capacity	E ₇	0% for R \leq 20 M Ω Unspecified for R > 20 M Ω

- Accuracy of generated voltage (Robc [Ω] \geq 1000* U_N [V]): -0% +30% from the set value
- nominal current: min 1 mA ... 1.4 mA
- adjustable lower limit within the range of 0.1 M Ω 9.9 M Ω with resolution of 0,1 M Ω
- adjustable measuring time: 3 s...3 min with a resolution of 1 s and option **Continuous test**
- detection of a dangerous voltage before commencing a measurement
- discharging the object tested

Note: For R < 50 k Ω , the uncertainty is not specified.

Measurement of insulation resistance using test voltage of 500V

Test range according to IEC 61557-2 for $U_N = 500\text{ V}$: 500 k Ω ...599.9 M Ω

Display range	Resolution	Measurement uncertainty (basic)
0 k Ω ...1999 k Ω	1 k Ω	\pm (5% m.v. + 8 digits)
2,00 M Ω ...19,99 M Ω	0,01 M Ω	
20,0 M Ω ...599,9 M Ω	0,1 M Ω	

Influencing factor	Designation	Additional uncertainty
Position	E ₁	0%
Supply voltage	E ₂	0%
Temperature	E ₃	0,1%/°C
Capacity	E ₇	0% for R \leq 20 M Ω Unspecified for R > 20 M Ω

- Accuracy of generated voltage (Robc [Ω] \geq 1000* U_N [V]): -0% +30% from the set value
- nominal current: min 1 mA...1.4 mA
- adjustable lower limit within the range of 0.1 M Ω 9.9 M Ω with resolution of 0,1 M Ω
- adjustable measuring time: 3 s...3 min with a resolution of 1 s and option **Continuous test**
- detection of a dangerous voltage before commencing a measurement
- discharging the object tested

Note: For R <50 k Ω , the uncertainty is not specified.

Flash test (only PAT-820)

Display range	Resolution	Measurement uncertainty (basic)
0,00 mA...2,50 mA	0,01 mA	± (5% w.m. + 5 cyfr)

- measurement voltage: 1500 V AC, 3000 V AC
- adjustable measuring time: 2 s...180 s
- adjustable upper limit in the range of: 0,01 mA...2,50 mA with resolution 0,01 mA / 0,1 mA

Measurement of substitute leakage current

Display range	Resolution	Measurement uncertainty (basic)
0,00 mA...3,99 mA	0,01 mA	± (5% m.v. + 2 digits)
4,0 mA...19,9 mA	0,1 mA	

Influencing factor	Designation	Additional uncertainty
Position	E ₁	0%
Supply voltage	E ₂	0%
Temperature	E ₃	0,075%/°C

- opening voltage: 25 V...50 V
- internal resistance of the testing device 2 kΩ ± 20%
- adjustable upper limit in the range of: 0.01 mA... 9.90 mA with resolution of 0.01 mA
- adjustable measuring time in the range of: 1 s...60 s with resolution of 1 s and option **Continuous test**

Measurement of PE leakage current

Note: In the half-time of the measurement, the tester automatically changes the polarity of the test socket and as a final result it displays the value of higher leakage current.

Display range	Resolution	Measurement uncertainty (basic)
0,00 mA...3,99 mA	0,01 mA	± (5% m.v. + 2 digits)
4,0 mA...19,9 mA	0,1 mA	

Influencing factor	Designation	Additional uncertainty
Position	E ₁	0%
Supply voltage	E ₂	0%
Temperature	E ₃	0,1%/°C
Power consumption of the tested unit	E ₄	0%
Low frequency magnetic field	E ₅	0%
The shape of the network voltage (CF)	E ₈	0%

- measurements are made using mains voltage
- adjustable upper limit in the range of: 0.01 mA... 9.90 mA with resolution of 0.01 mA
- adjustable measuring time in the range of: 1 s...60 s with resolution of 1 s and option **Continuous test**
- measurement for frequency band 20 Hz...2 kHz

Measurement of differential leakage current

Note: In the half-time of the measurement, the tester automatically changes the polarity of the test socket and as a final result it displays the value of higher leakage current.

Display range	Resolution	Measurement uncertainty (basic)
0,00 mA...3,99 mA	0,01 mA	± (5% m.v. + 2 digits)
4,0 mA...19,9 mA	0,1 mA	

Influencing factor	Designation	Additional uncertainty	
Position	E ₁	0%	
Supply voltage	E ₂	0%	
Temperature	E ₃	0,1%/°C	
Power consumption of the tested unit	E ₄	Common current	Additional uncertainty
		0 A...4 A	0
		4 A...8 A	±0,03 mA
		8 A...16 A	±0,08 mA
Low frequency magnetic field	E ₅	2 digits I < 4 mA 0 digits for I ≥ 4 mA	
The shape of the network voltage (CF)	E ₈	0%	

- adjustable upper limit in the range of: 0.01 ... 9.9 mA with resolution of 0.01mA/0.1mA
- adjustable measuring time in the range of: 1 s...60 s with resolution of 1 s and option **Continuous test**
- measurement for frequency band 20 Hz...2 kHz

Measurement of PE leakage current and differentia current with clamp

Display range	Resolution	Measurement uncertainty (basic)
0,00 mA...9,99 mA	0,01 mA	±(5% m.v. + 5 digits)
10,0 mA...99,9 mA	0,1 mA	

- Basic uncertainty does not include the uncertainty of the current clamp
- adjustable upper limit in the range of: 0,01 mA...19,90 mA with resolution of 0,01 mA
- adjustable measuring time in the range of: 1...180 s with resolution of 1 s and option **Continuous test**
- measurement for frequency band 20 Hz...2 kHz

Measurement of touch leakage current

Note: The tester changes polarity automatically in the mains test socket during test, and it displays higher measured value as the final result.

Display range	Resolution	Measurement uncertainty (basic)
0,000 mA...4,999 mA	0,001 mA	± (5% m.v. + 3 digits)

Influencing factor	Designation	Additional uncertainty
Position	E ₁	0%
Supply voltage	E ₂	0%
Temperature	E ₃	0,25 µA/°C
The shape of the network voltage (CF)	E ₈	0%

- the bandwidth of test current results from the measuring system with adjusted touch current which simulates human perception and reaction, in accordance with EN 60990:2002
- adjustable upper limit in the range of: 0.01 mA... 1.99 mA with resolution 0,01 mA
- adjustable measuring time in the range of: 1 s...60 s with resolution of 1 s and option **Continuous test**

S Power Measurement

Display range	Resolution	Measurement uncertainty (basic)*
0 VA...999 VA	1 VA	± (5% m.v. + 3 digits)
1 kVA...3,99 kVA	0,01 kVA	

- adjustable measuring time in the range of: 1 s...60 s, with resolution of 1 s and option **Continuous test** (enabled by default), in AUTOTEST only adjustable: 1...60 s, with resolution of 1 s
- * only for current measurement with clamp ± (8% m.v. + 5 digits)

P Power measurement

Display range	Resolution	Basic uncertainty*
0 VA...999 W	1 W	± (5% m.v. + 3 digits)
1 kVA...3,99 kW	0,01 kW	

- adjustable measuring time in the range of: 1 s...60 s, with resolution of 1 s and option **Continuous test** (enabled by default), in AUTOTEST only adjustable: 1...60 s, with resolution of 1 s
- * only for current measurement with clamp ± (8% m.v. + 5 digits)

PF Power Factor

Display range	Resolution	Basic uncertainty
0,00...1,00	0,01	± (10% m.v. + 5 digits)

- adjustable measuring time in the range of: 1 s...60 s, with resolution of 1 s and option **Continuous test** (enabled by default), in AUTOTEST only adjustable: 1...60 s, with resolution of 1 s

Current Consumption measurement during power measurement

Display range	Resolution	Basic uncertainty
0,00 A...15,99 A	0,01 A	± (2% m.v. + 3 digits)

- adjustable measuring time in the range of: 1 s...60 s, with resolution of 1 s and option **Continuous test** (enabled by default), in AUTOTEST only adjustable: 1...60 s, with resolution of 1 s

Current Consumption measurement with clamp during power measurement

Display range	Resolution	Basic uncertainty
100 mA...999 mA	1 mA	±(5% m.v. + 5 digits)
1,00 A...9,99 A	0,01 A	
10,0 A...24,9 A	0,1 A	

- basic uncertainty above does not include uncertainty of measurement clamp
- adjustable measuring time in the range of: 1 s...60 s, with resolution of 1 s and option **Continuous test** (enabled by default), in AUTOTEST only adjustable: 1...60 s, with resolution of 1 s

Voltage measurement in test socket

Display range	Resolution	Basic uncertainty
195,0 V...265,0 V	0,1 V	±(2% m.v. + 2 digits)

Measurement of RCD parameters

RCD tripping time measurement for sine t_A differential current

Measurement range in acc. with IEC 61557: 0 ms ... up to the upper limit of displayed value

RCD type	Rated Current Multiplication Factor	Measurement range	Resolution	Basic uncertainty
General	0,5 $I_{\Delta n}$	0..300 ms	1 ms	$\pm 2\%$ m.v. ± 2 digits ¹⁾
	1 $I_{\Delta n}$			
	2 $I_{\Delta n}$	0..150 ms		
	5 $I_{\Delta n}$	0..40 ms		

1) for $I_{\Delta n} = 10$ mA and 0,5 $I_{\Delta n}$ uncertainty is $\pm 2\%$ m. v. ± 3 digits

RCD disconnecting I_A current measurement for a sine AC test current

Measurement range in acc. with IEC 61557: $(0,3...1,0)I_{\Delta n}$

Selected rated RCD current	Measurement range	Resolution	Basic uncertainty	Measurement range
10 mA	3,0 mA..10,0 mA	0,1 mA	$0,3 \times I_{\Delta n}..1,0 \times I_{\Delta n}$	$\pm 5\% I_{\Delta n}$
15 mA	4,5 mA..15,0 mA			
30 mA	9,0 mA..30,0 mA			

- test current flow time max. 3200 ms
- AC current RCD type testing
- measurement of RCDs with nominal residual currents of: 10 mA, 15 mA i 30 mA
- t_A disconnecting time measurement for $\frac{1}{2}I_{\Delta n}$, $1I_{\Delta n}$, $2I_{\Delta n}$ i $5I_{\Delta n}$
- start of the measurement from the positive or negative half sine period of the test current

Other technical specification

a) type of insulation.....double, EN 61010-1 and IEC 61557 compliant

NOTE!
During the measurement of S, I_A , I_{PE} and I_T PE of the power supply socket is connected to PE of the test socket.

- b) measurement category acc. to EN 61010-1II 300 V
- c) protection class of enclosure acc. to EN 60529 IP40 (IP67 with the lid closed)
- d) power supply of the tester 195 V...265 V, 50 Hz
- e) load current..... max 16 A (230 V)
- f) dimensions 390 mm x 308 mm x 172 mm
- g) weight approx. 5.0 kg
- h) storage temperature.....-20°C...+70°C
- i) operating temperature.....-10°C...+50°C
- j) humidity 20%...80%
- k) nominal temperature..... +20°C...+25°C
- l) reference humidity 40%...60%
- m) altitude..... < 2000 m
- n) display TFT 7 800x480
- o) memory min. 4 GB
- p) data transfer USB 2.0
- q) measurement standards EN 50678, EN 50699
- r) quality standards..... development, design and manufacturing are ISO 9001, ISO 14001 compliant
- s) the product meets the EMC requirements acc. to EN 61326-1 and EN 61326-2-2

Note:

During the measurement of PE continuity with PE 10/25 current the tester may induce interferences of the values exceeding allowable limits defined in EN 61326-1 and cause interferences in other devices.

Note:

F500mA/250V fuse protects R_{PE} 200mA and I_T measurements.

Note:

When needed, user can reset iPAT by pressing small button at the bottom of the tiny hole marked RESET. In order to reset use thin item (pin, wire). If this doesn't help turn off the tester for approx. 2 mins and switch it on again.

11 Accessories

The current list of accessories can be found on the manufacturer's website.

11.1 Standard accessories

Standard set of accessories supplied along with the tester includes:

- Mains cable with IEC C19 plug – 1 pc. – **WAPRZZAS1**
- Test lead 1,8 m, orange, (10 A / 25 A, terminated in a crocodile clip) – 1 pc. – **WAPRZ1X8ORKS**
- Test lead 1,8 m, red, 5 kV (banana plugs) – 2 pcs. (only PAT-820) – **WAPRZ1X8REBB**
- Pin probe, red 5 kV (banana socket) – 2 pcs. (only PAT-820) – **WASONREOGB2**
- USB cable – **WAPRZUSB**
- Fuse 0314 015.VXP 15 A 250 VAC 6.3x32 mm Littlefuse – 2 pcs. – **WAPOZB15PAT**
- User manual
- Factory calibration certificate

11.2 Optional accessories

Additionally, the following accessories, that are not included in the scope of standard accessories set, are available:

- Calibration certificate with accreditation
- Cable – adapter Shuko / IEC (for testing extensions) – **WAADAPATIEC2**
- Three phase socket adapter 16 A* – **WAADAPAT16P**
- Three phase socket adapter 16 A, switchable** – **WAADAPAT16PR**
- PAT16-C three-phase socket adapter 16 A (4P) – **WAADAPAT16C**
- PAT16-CPR three-phase socket adapter 16 A (4P, switchable) – **WAADAPAT16CPR**
- Three phase socket adapter 32 A* – **WAADAPAT32P**
- Three phase socket adapter 32 A switchable ** – **WAADAPAT32PR**
- PAT32-C three-phase socket adapter 32 A (4P) – **WAADAPAT32C**
- PAT32-CPR three-phase socket adapter 32 A (4P, switchable) – **WAADAPAT32CPR**
- Adapter for industrial sockets 16 A*** – **WAADAPAT16F1**
- Adapter for industrial sockets 32 A*** – **WAADAPAT32F1**

- Crocodile clip, red, 1 kV, 20 A – **WAKRORE20K02**
- Kelvin clamp, 1 kV, 25 A – **WAKROKELK06**
- Crocodile clip, blue, 1 kV, 20 A – **WAKROBU20K02**
- Double-wire test lead 2,1 m (IEC C13 / banana plug) – **WAPRZ2X1DZIECB**
- Double-wire test lead 1,5 m (PAT/banana plug) – **WAPRZ1X5DZBB**
- Pin probe, red 1 kV (banana socket) – **WASONREOGB1**
- High-current pin probe 1 kV (banana sockets) – **WASONSPGB1**
- Adapter IEC IEC 60320 C6 Plug to IEC 60320 C13 Connector block – **WAADAPATIEC1**
- USB barcode reader, 2D, USB – **WAADACK2D**

NOTE!

To customize the newly bought reader DS4203 / DS4208 to cooperation with the PAT tester, connect it to the USB socket of turned on computer and read the code below:



- USB printer for reports/codes, portable – **WAADAD2**
- Label Roll – Black on White for D2 printer (SATO) – **WANAKD2**
- Ribbon for D2 printer (SATO) – **WANAKD2BAR**
- Sonel PAT Analysis software – **WAPROSONPAT3**

* - These adapters have permanently shorted lines of three-phase socket: L1, L2, L3 and they are connected to L line of one-phase socket.

** - These adapters have a rotary switch allowing the following connections:

- 1 - L of test socket connected to L1
- 2 - L of test socket connected to L2
- 3 - L of test socket connected to L3
- 4 - L of test socket connected to L1+L2+L3 (shorted)

*** - These adapters are designed for testing security of devices powered from industrial sockets 16A and 32A, providing that the tested device does not consume current higher than 16A. The adapters enable users to perform all measurements available in Metro iPAT testers on the network measurement socket.

NOTE!

Adapters for three-phase sockets and for 32A industrial sockets must not be used for the following measurements: leakage currents I_{PE} and I_{Δ} , power and current consumption (for detailed information on the use of adapters see PAT Adapter's User's Guide).

12 Manufacturer

The manufacturer of the device, which also provides warranty and post-warranty services is:

SONEL S.A.
Wokulskiego 11
58-100 Świdnica
Poland
tel. (+48) 74 858 38 60
fax (+48) 74 858 38 09
e-mail: export@sonel.pl
web page: www.sonel.pl

Note:

Service repairs must be undertaken solely by the manufacturer.

13 Laboratory services

SONEL Testing and Calibration Laboratory has been accredited by the Polish Center for Accreditation (PCA) - certificate no. AP 173.

Laboratory offers calibration for the following instruments that are used for measuring electrical and non-electrical parameters.



AP 173

● METERS FOR MEASUREMENTS OF ELECTRICAL PARAMETERS

- voltage meters,
- current meters (including clamp meters),
- resistance meters,
- insulation resistance meters,
- earth resistance and resistivity meters,
- RCD meters,
- short-circuit loop impedance meters,
- power quality analyzers,
- portable appliance testers (PAT),
- power meters,
- multimeters,
- multifunction meters covering the functions of the above-mentioned instruments,

● ELECTRICAL STANDARDS

- calibrators,
- resistance standards,

● METERS FOR MEASUREMENTS OF NON-ELECTRICAL PARAMETERS

- pyrometers,
- thermal imagers,
- luxmeters.

The Calibration Certificate is a document that presents a relation between the calibration standard of known accuracy and meter indications with associated measurement uncertainties. The calibration standards are normally traceable to the national standard held by the National Metrological Institute.

According to ILAC-G24 „Guidelines for determination of calibration intervals of measuring instruments”, SONEL S.A. recommends periodical metrological inspection of the instruments it manufactures no less frequently than once every 12 months.

For new instruments provided with the Calibration Certificate or Validation Certificate at the factory, re-calibration should be performed within 12 months from the date of purchase, however, no later than 24 months from the date of purchase.

ATTENTION !

The person performing the measurements should be absolutely sure about the efficiency of the device being used. Measurements made with an inefficient meter can contribute to an incorrect assessment of the effectiveness of health protection and even human life.

NOTES

NOTES



SONEL S.A.
Wokulskiego 11
58-100 Swidnica
Poland



+48 74 858 38 60
+48 74 858 38 00
fax +48 74 858 38 09

e-mail: export@sonel.pl
www.sonel.pl